

TABLE OF CONTENTS

Table of Contents	Page
Tag Specifications	2
General Information	3
Blank Tags	
• 13 pt. CSU Colors	4
• 13 pt. CSU Fluorescent	5
• 15 pt. oversize	5
• 10 & 13 pt. manila	6
• Tyvek®	7
• Vinyl	7
• Cloth	8
Blank Continuous Pinfeed Tags	8
Inventory Tags	
• 1-Part Inventory Tags	9
• Carbon Interleaf manifolds (multipart)	10
• Glatfelter carbonless manifolds (multipart)	11
• Transfer Tape, Horizontal, Blank	12
Production & Safety Tags	13 - 15
Retail Tags	
• Blank	16
• Garment	17
• Business Control	18
• Carpet - Furniture	19
• Sale	20-23
• Specialized	24
Automotive Tags	25-26
Entertainment	27
Hospitality Tags	
• Valet Tags	28
• Baggage Tags	29-30
• Coat Check Tags	31
• Specialized	32
Attachments	33
Index	34 - 39

Custom Capabilities

- Tags, Labels and Combinations
- Barcoding
- Variable Imaging
- Consecutive Numbering
- 4-color Process
- Flexographic and Flatbed Letterpress Processes
- Finishing
- Multi-ply Constructions

TAG SPECIFICATIONS



METAL WIRED

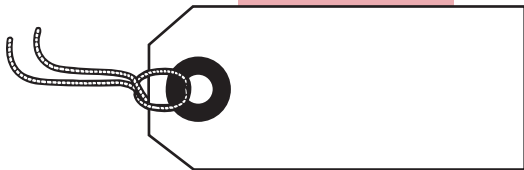

LOOPED STRUNG

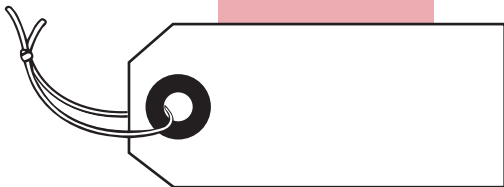

KNOTTED STRUNG

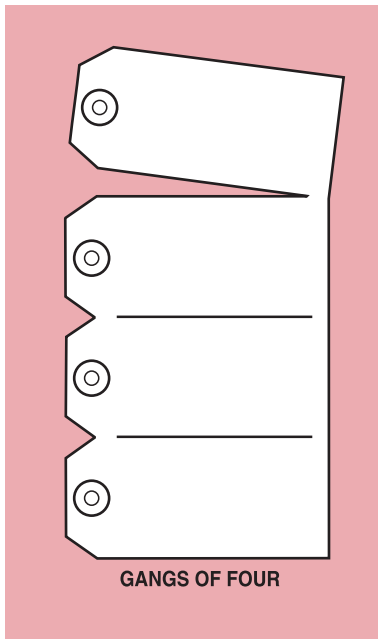

GANGS OF FOUR

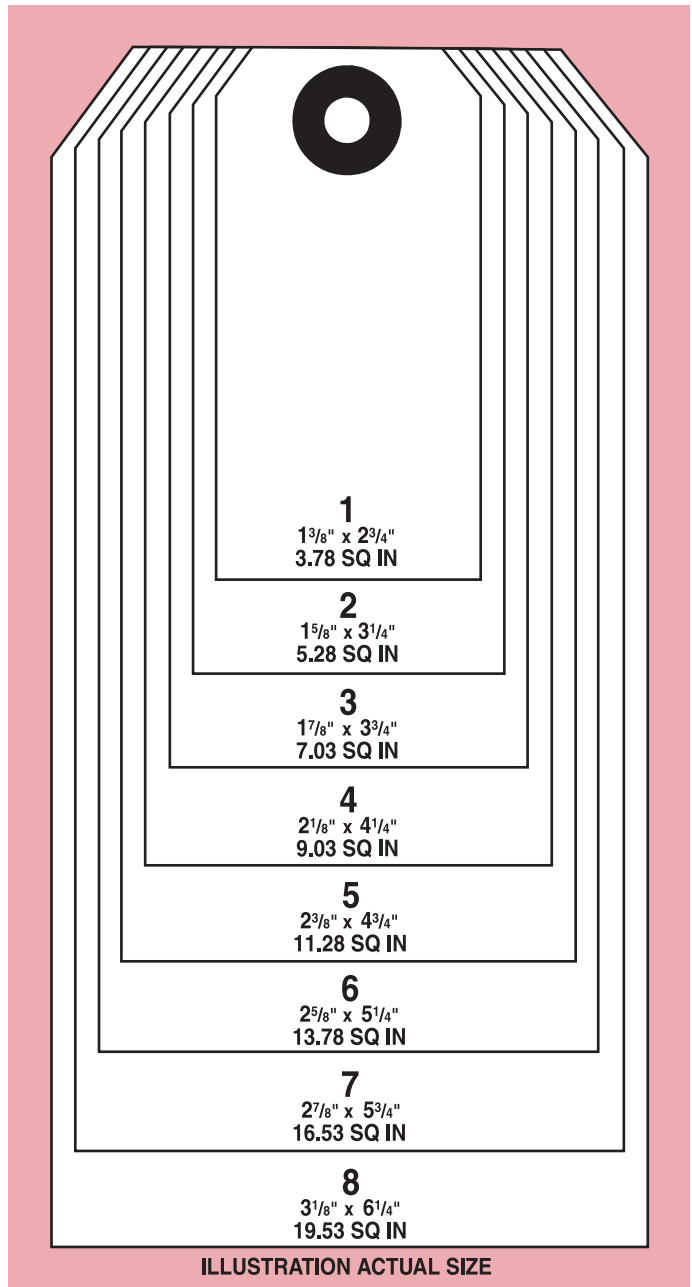

Please Note:

1. 12"- 26 gauge double wire is used on pre-wired stock products.
2. 23 and 21 heavy gauge wiring is also available by special order.

Tag Stock

SU – this stock is sometimes referred to as a Sulfate Stock, 100% chemical wood pulp
CSU – starts as an uncoated white stock and then coated with color.

Blank Tags

High quality tags perfect for many different marking uses. 10 pt. SU, 13 pt. SU and CSU grades available in a variety of standard sizes. Colored and fluorescent tags are available in 13 pt. CSU. Ideal for color coding and easy identification. Many tags are stocked with strings or wires attached. Blank tag colors and descriptions are listed on pages 4 - 7. All tags are packed in master shipping containers. See your price list for additional details.

Continuous Blank Tags

Blank continuous tags provide a practical and inexpensive alternative to custom printed tags. Choose from durable, tear resistant Tyvek®, white tag stock or two-part Glatfelter carbonless. See page 8 for more information.

Tyvek® Tags

Manufactured from Spunbonded Olefin, this is our toughest, most durable shipping tag available. Because it is tear resistant, even when wet, and resists chemicals and mildew, this tag is an excellent choice for tough environments. Size and descriptions are listed on page 7.

Vinyl Tags

Produced on 10 Mil calendared vinyl, these tags provide a smooth writing surface on a durable tag. Moisture and oil resistant, high puncture and tear strength. Size and descriptions are listed on page 7.

Inventory Tags

The industry's most complete selection of one-part, two-part and three-part manifold inventory tags aid in keeping inventory in check. The tags are constructed of 10 pt. tag & carbon interleaf bonds, carbonless stocks or Tyvek®. See pages 9 - 12 for descriptions.

Stringing and Wiring

Save time and effort by having strings or wires added to your stock tag purchase. The strings and wires can be pre-attached or you can purchase them and attach them yourself.

BLANK TAGS



Colors 13 pt. CSU

White	Yellow	Lilac	Red	Size	Dimensions	Box	Ctn	Price
P11311	P11321	P11331	P11341	1	1 ³ / ₈ " x 2 ³ / ₄ "	1000	5BX	
P11312	P11322	P11332	P11342	2	1 ⁵ / ₈ " x 3 ¹ / ₄ "	1000	5BX	
P11313	P11323	P11333	P11343	3	1 ⁷ / ₈ " x 3 ³ / ₄ "	1000	5BX	
P11314	P11324	P11334	P11344	4	2 ¹ / ₈ " x 4 ¹ / ₄ "	1000	5BX	
P11315	P11325	P11335	P11345	5	2 ³ / ₈ " x 4 ³ / ₄ "	1000	5BX	
P11315W	P11325W	P11335W	P11345W	5	2 ³ / ₈ " x 4 ³ / ₄ "	1000	5BX	
P11316	P11326	P11336	P11346	6	2 ⁵ / ₈ " x 5 ¹ / ₄ "	1000	5BX	
P11317	P11327	P11337	P11347	7	2 ⁷ / ₈ " x 5 ³ / ₄ "	1000	5BX	
P11318	P11328	P11338	P11348	8	3 ¹ / ₈ " x 6 ¹ / ₄ "	1000	5BX	
P11318W	P11328W	P11338W	P11348W	8	3 ¹ / ₈ " x 6 ¹ / ₄ "	1000	5BX	
Dk. Blue	Lt. Blue	Lt. Green	Dk. Green	Size	Dimensions	Box	Ctn	Price
P11351	P11351L	P11361	P11361D	1	1 ³ / ₈ " x 2 ³ / ₄ "	1000	5BX	
P11352	P11352L	P11362	P11362D	2	1 ⁵ / ₈ " x 3 ¹ / ₄ "	1000	5BX	
P11353	P11353L	P11363	P11363D	3	1 ⁷ / ₈ " x 3 ³ / ₄ "	1000	5BX	
P11354	P11354L	P11364	P11364D	4	2 ¹ / ₈ " x 4 ¹ / ₄ "	1000	5BX	
P11355	P11355L	P11365	P11365D	5	2 ³ / ₈ " x 4 ³ / ₄ "	1000	5BX	
P11355W	P11355LW	P11365W	P11365DW	5	2 ³ / ₈ " x 4 ³ / ₄ "	1000	5BX	
P11356	P11356L	P11366	P11366D	6	2 ⁵ / ₈ " x 5 ¹ / ₄ "	1000	5BX	
P11357	P11357L	P11367	P11367D	7	2 ⁷ / ₈ " x 5 ³ / ₄ "	1000	5BX	
P11358	P11358L	P11368	P11368D	8	3 ¹ / ₈ " x 6 ¹ / ₄ "	1000	5BX	
P11358W	P11358LW	P11368W	P11368DW	8	3 ¹ / ₈ " x 6 ¹ / ₄ "	1000	5BX	
Orange	Pink	Gray	Brown	Size	Dimensions	Box	Ctn	Price
P11371	P11381	P11391	P11911	1	1 ³ / ₈ " x 2 ³ / ₄ "	1000	5BX	
P11372	P11382	P11392	P11912	2	1 ⁵ / ₈ " x 3 ¹ / ₄ "	1000	5BX	
P11373	P11383	P11393	P11913	3	1 ⁷ / ₈ " x 3 ³ / ₄ "	1000	5BX	
P11374	P11384	P11394	P11914	4	2 ¹ / ₈ " x 4 ¹ / ₄ "	1000	5BX	
P11375	P11385	P11395	P11915	5	2 ³ / ₈ " x 4 ³ / ₄ "	1000	5BX	
P11375W	P11385W	P11395W	P11915W	5	2 ³ / ₈ " x 4 ³ / ₄ "	1000	5BX	
P11376	P11386	P11396	P11916	6	2 ⁵ / ₈ " x 5 ¹ / ₄ "	1000	5BX	
P11377	P11387	P11397	P11917	7	2 ⁷ / ₈ " x 5 ³ / ₄ "	1000	5BX	
P11378	P11388	P11398	P11918	8	3 ¹ / ₈ " x 6 ¹ / ₄ "	1000	5BX	
P11378W	P11388W	P11398W	P11918W	8	3 ¹ / ₈ " x 6 ¹ / ₄ "	1000	5BX	
Ivory	Salmon			Size	Dimensions	Box	Ctn	Price
P11931	P11951			1	1 ³ / ₈ " x 2 ³ / ₄ "	1000	5BX	
P11932	P11952			2	1 ⁵ / ₈ " x 3 ¹ / ₄ "	1000	5BX	
P11933	P11953			3	1 ⁷ / ₈ " x 3 ³ / ₄ "	1000	5BX	
P11934	P11954			4	2 ¹ / ₈ " x 4 ¹ / ₄ "	1000	5BX	
P11935	P11955			5	2 ³ / ₈ " x 4 ³ / ₄ "	1000	5BX	
P11935W	P11955W			5	2 ³ / ₈ " x 4 ³ / ₄ "	1000	5BX	
P11936	P11956			6	2 ⁵ / ₈ " x 5 ¹ / ₄ "	1000	5BX	
P11937	P11957			7	2 ⁷ / ₈ " x 5 ³ / ₄ "	1000	5BX	
P11938	P11958			8	3 ¹ / ₈ " x 6 ¹ / ₄ "	1000	5BX	
P11938W	P11958W			8	3 ¹ / ₈ " x 6 ¹ / ₄ "	1000	5BX	

W indicates pre-attached 12" x 26 gauge double wire

BLANK TAGS

Fluorescent 13 pt. CSU

Red	Yellow	Green	Size	Dimensions	Box	Ctn	Price
P11701	P11711	P11721	1	1 $\frac{3}{8}$ " x 2 $\frac{3}{4}$ "	1000	5BX	
P11702	P11712	P11722	2	1 $\frac{5}{8}$ " x 3 $\frac{1}{4}$ "	1000	5BX	
P11703	P11713	P11723	3	1 $\frac{7}{8}$ " x 3 $\frac{3}{4}$ "	1000	5BX	
P11704	P11714	P11724	4	2 $\frac{1}{8}$ " x 4 $\frac{1}{4}$ "	1000	5BX	
P11705	P11715	P11725	5	2 $\frac{3}{8}$ " x 4 $\frac{3}{4}$ "	1000	5BX	
P11705W	P11715W	P11725W	5	2 $\frac{3}{8}$ " x 4 $\frac{3}{4}$ "	1000	5BX	
P11706	P11716	P11726	6	2 $\frac{5}{8}$ " x 5 $\frac{1}{4}$ "	1000	5BX	
P11706W	P11716W	P11726W	6	2 $\frac{5}{8}$ " x 5 $\frac{1}{4}$ "	1000	5BX	
P11707	P11717	P11727	7	2 $\frac{7}{8}$ " x 5 $\frac{3}{4}$ "	1000	5BX	
P11708	P11718	P11728	8	3 $\frac{1}{8}$ " x 6 $\frac{1}{4}$ "	1000	5BX	
P11708W	P11718W	P11728W	8	3 $\frac{1}{8}$ " x 6 $\frac{1}{4}$ "	1000	5BX	

Pink	Orange	Size	Dimensions	Box	Ctn	Price
P11731	P11741	1	1 $\frac{3}{8}$ " x 2 $\frac{3}{4}$ "	1000	5BX	
P11732	P11742	2	1 $\frac{5}{8}$ " x 3 $\frac{1}{4}$ "	1000	5BX	
P11733	P11743	3	1 $\frac{7}{8}$ " x 3 $\frac{3}{4}$ "	1000	5BX	
P11734	P11744	4	2 $\frac{1}{8}$ " x 4 $\frac{1}{4}$ "	1000	5BX	
P11735	P11745	5	2 $\frac{3}{8}$ " x 4 $\frac{3}{4}$ "	1000	5BX	
P11735W	P11745W	5	2 $\frac{3}{8}$ " x 4 $\frac{3}{4}$ "	1000	5BX	
P11736	P11746	6	2 $\frac{5}{8}$ " x 5 $\frac{1}{4}$ "	1000	5BX	
P11736W	P11746W	6	2 $\frac{5}{8}$ " x 5 $\frac{1}{4}$ "	1000	5BX	
P11737	P11747	7	2 $\frac{7}{8}$ " x 5 $\frac{3}{4}$ "	1000	5BX	
P11738	P11748	8	3 $\frac{1}{8}$ " x 6 $\frac{1}{4}$ "	1000	5BX	
P11738W	P11748W	8	3 $\frac{1}{8}$ " x 6 $\frac{1}{4}$ "	1000	5BX	

15 pt. - Oversize

15 pt.	Description	Dimensions	Box	Ctn	Price
P11240	Manila Tag	3 $\frac{3}{4}$ " x 7 $\frac{1}{2}$ "	500	5BX	
P11250	Manila Tag	4"x8"	500	4BX	
P11251	White Tag	4"x8"	500	4BX	
P11252	Yellow Tag	4"x8"	500	4BX	
P11253	Red Tag	4"x8"	500	4BX	
P11254	Lt. Blue	4"x8"	500	4BX	
P11255	Dk. Blue	4"x8"	500	4BX	
P11256	Lt. Green	4"x8"	500	4BX	
P11257	Orange	4"x8"	500	4BX	
P11258	Pink	4"x8"	500	4BX	
P11259	Grey	4"x8"	500	4BX	

W indicates pre-attached 12" x 26 gauge wire double wire

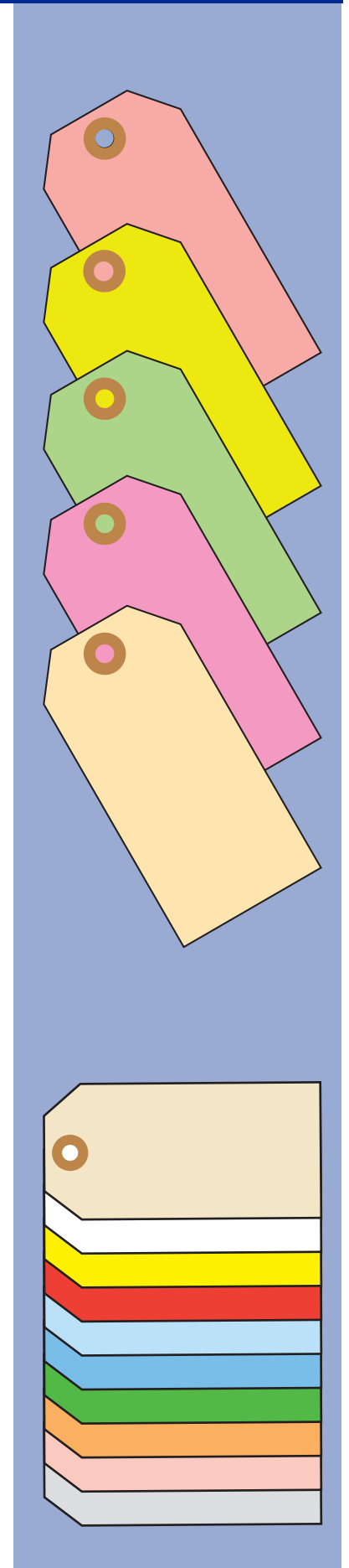

BLANK TAGS

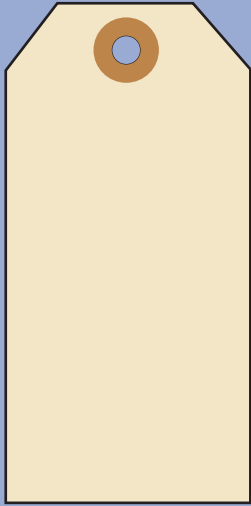

Manila 10 and 13 pt.

10 pt.	13 pt.	Size	Dimensions	Box	Ctn	Price
P11491	P11301	1	1 $\frac{3}{8}$ " x 2 $\frac{3}{4}$ "	1000	5BX	
P11492	P11302	2	1 $\frac{5}{8}$ " x 3 $\frac{1}{4}$ "	1000	5BX	
P11493	P11303	3	1 $\frac{7}{8}$ " x 3 $\frac{3}{4}$ "	1000	5BX	
P11494	P11304	4	2 $\frac{1}{8}$ " x 4 $\frac{1}{4}$ "	1000	5BX	
P11495	P11305	5	2 $\frac{3}{8}$ " x 4 $\frac{3}{4}$ "	1000	5BX	
P11496	P11306	6	2 $\frac{5}{8}$ " x 5 $\frac{1}{4}$ "	1000	5BX	
P11497	P11307	7	2 $\frac{7}{8}$ " x 5 $\frac{3}{4}$ "	1000	5BX	
P11498	P11308	8	3 $\frac{1}{8}$ " x 6 $\frac{1}{4}$ "	1000	5BX	

Manila 10 and 13 pt. - String 12" Looped

10 pt.	13 pt.	Size	Dimensions	Box	Ctn	Price
P11591	P11501	1	1 $\frac{3}{8}$ " x 2 $\frac{3}{4}$ "	1000	5BX	
P11592	P11502	2	1 $\frac{5}{8}$ " x 3 $\frac{1}{4}$ "	1000	5BX	
P11593	P11503	3	1 $\frac{7}{8}$ " x 3 $\frac{3}{4}$ "	1000	5BX	
P11594	P11504	4	2 $\frac{1}{8}$ " x 4 $\frac{1}{4}$ "	1000	5BX	
P11595	P11505	5	2 $\frac{3}{8}$ " x 4 $\frac{3}{4}$ "	1000	5BX	
P11596	P11506	6	2 $\frac{5}{8}$ " x 5 $\frac{1}{4}$ "	1000	5BX	
P11597	P11507	7	2 $\frac{7}{8}$ " x 5 $\frac{3}{4}$ "	1000	5BX	
P11598	P11508	8	3 $\frac{1}{8}$ " x 6 $\frac{1}{4}$ "	1000	5BX	

Manila 10 and 13 pt. - Wired

10 pt.	13 pt.	Size	Dimensions	Box	Ctn	Price
P11691	P11601	1	1 $\frac{3}{8}$ " x 2 $\frac{3}{4}$ "	1000	5BX	
P11692	P11602	2	1 $\frac{5}{8}$ " x 3 $\frac{1}{4}$ "	1000	5BX	
P11693	P11603	3	1 $\frac{7}{8}$ " x 3 $\frac{3}{4}$ "	1000	5BX	
P11694	P11604	4	2 $\frac{1}{8}$ " x 4 $\frac{1}{4}$ "	1000	5BX	
P11695	P11605	5	2 $\frac{3}{8}$ " x 4 $\frac{3}{4}$ "	1000	5BX	
P11696	P11606	6	2 $\frac{5}{8}$ " x 5 $\frac{1}{4}$ "	1000	5BX	
P11697	P11607	7	2 $\frac{7}{8}$ " x 5 $\frac{3}{4}$ "	1000	5BX	
P11698	P11608	8	3 $\frac{1}{8}$ " x 6 $\frac{1}{4}$ "	1000	5BX	

Manila 13 pt. - Gangs of Four

13 pt.	Size	Dimensions	Box	Ctn	Price
P11804	4	2 $\frac{1}{8}$ " x 4 $\frac{1}{4}$ "	1000	5BX	
P11805	5	2 $\frac{3}{8}$ " x 4 $\frac{3}{4}$ "	1000	5BX	
P11806	6	2 $\frac{5}{8}$ " x 5 $\frac{1}{4}$ "	1000	5BX	
P11808	8	3 $\frac{1}{8}$ " x 6 $\frac{1}{4}$ "	1000	5BX	

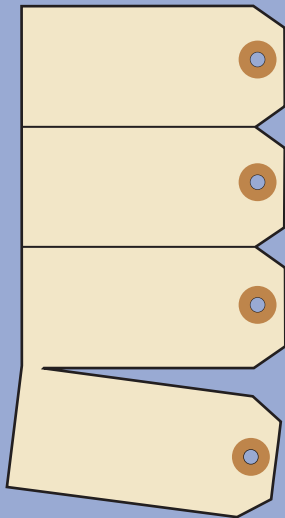

BLANK TAGS FOR CHALLENGING ENVIRONMENTS

Tyvek® 1079 - with reinforcing metal eyelet

White	Red	Yellow	Green	Blue	Size	Dimensions	Box	Ctn	Price
P11441					1	1 $\frac{3}{8}$ " x 2 $\frac{3}{4}$ "	1000	5BX	
P11441W					1	1 $\frac{3}{8}$ " x 2 $\frac{3}{4}$ "	1000	5BX	
P11442					2	1 $\frac{5}{8}$ " x 3 $\frac{1}{4}$ "	1000	5BX	
P11442W					2	1 $\frac{5}{8}$ " x 3 $\frac{1}{4}$ "	1000	5BX	
P11443					3	1 $\frac{7}{8}$ " x 3 $\frac{3}{4}$ "	1000	5BX	
P11443W					3	1 $\frac{7}{8}$ " x 3 $\frac{3}{4}$ "	1000	5BX	
P11444					4	2 $\frac{1}{8}$ " x 4 $\frac{1}{4}$ "	1000	5BX	
P11444W					4	2 $\frac{1}{8}$ " x 4 $\frac{1}{4}$ "	1000	5BX	
P11445	11415	11425	11435	11455	5	2 $\frac{3}{8}$ " x 4 $\frac{3}{4}$ "	1000	5BX	
P11445W	11415W	11425W	11435W	11455W	5	2 $\frac{3}{8}$ " x 4 $\frac{3}{4}$ "	1000	5BX	
P11446					6	2 $\frac{5}{8}$ " x 5 $\frac{1}{4}$ "	1000	5BX	
P11446W					6	2 $\frac{5}{8}$ " x 5 $\frac{1}{4}$ "	1000	5BX	
P11447					7	2 $\frac{7}{8}$ " x 5 $\frac{3}{4}$ "	1000	5BX	
P11447W					7	2 $\frac{7}{8}$ " x 5 $\frac{3}{4}$ "	1000	5BX	
P11448	11418	11428	11438	11458	8	3 $\frac{1}{8}$ " x 6 $\frac{1}{4}$ "	1000	5BX	
P11448W	11418W	11428W	11438W	11458W	8	3 $\frac{1}{8}$ " x 6 $\frac{1}{4}$ "	1000	5BX	

Colored Vinyl Tags - with metal eyelet

White	Red	Yellow	Green	Blue	Orange	Size	Dimensions	Box	Ctn	Price
P14305	P14365	P14325	P14385	P14375	P14395	5	2 $\frac{3}{8}$ " x 4 $\frac{3}{4}$ "	500	10BX	
P14308	P14368	P14328	P14388	P14378	P14398	8	3 $\frac{1}{8}$ " x 6 $\frac{1}{4}$ "	500	10BX	

Colored Vinyl's are shrinkwrapped in packs of 100

Tyvek® is a registered trademark of DuPont for its brand of protective material.

Colored Vinyl Circle Tags - with metal eyelet

Description	Dimensions	Box	Ctn	Price
P14323 3" Yellow Circle Vinyl Tag	3" x 3"	500	10BX	
P14343 3" Red Circle Vinyl Tag	3" x 3"	500	10BX	
P14353 3" Blue Circle Vinyl Tag	3" x 3"	500	10BX	
P14363 3" Green Circle Vinyl Tag	3" x 3"	500	10BX	
P14373 3" White Circle Vinyl Tag	3" x 3"	500	10BX	

Shrinkwrapped in packs of 100

W indicates pre-attached 12" x 26 gauge double wire

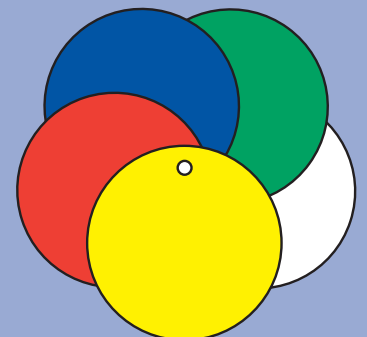
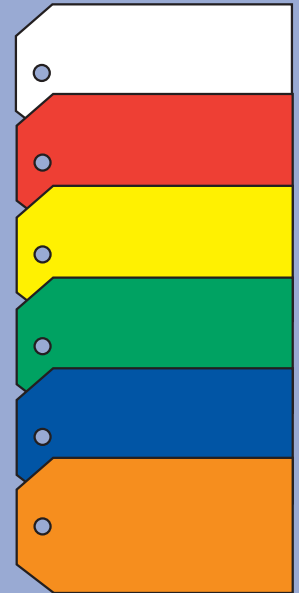
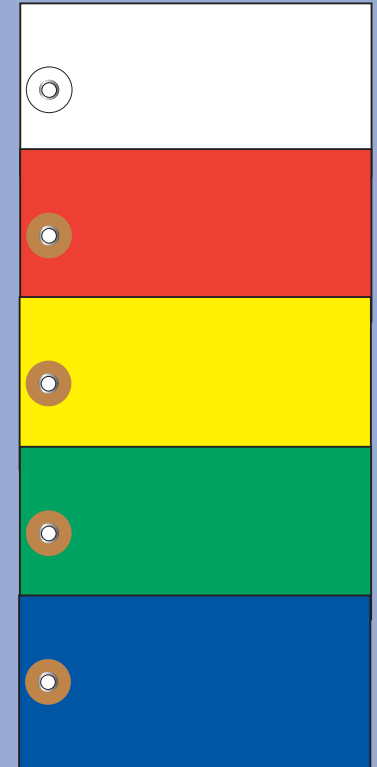

BLANK TAGS FOR SPECIAL APPLICATIONS

P60501

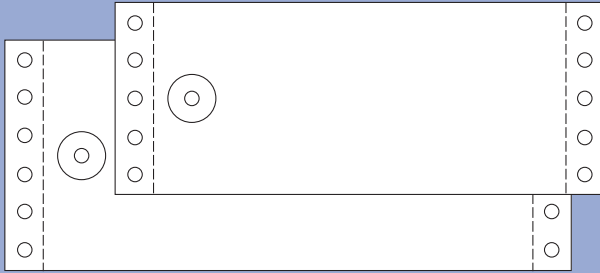

P60503



P60505

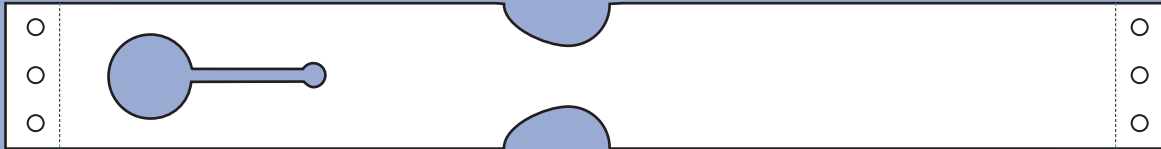

P60506

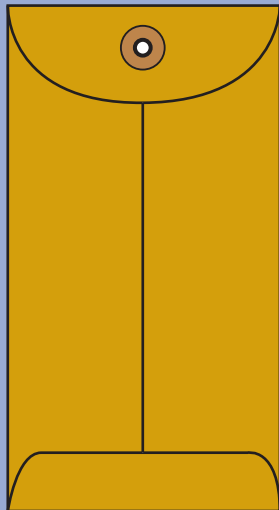

P17411

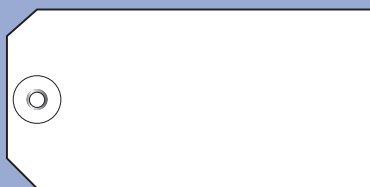

P11181
P11185

Continuous Blank Pinfeed Tags

Tough Mylar® patch on back, fan-folded, marginally punched and perforated. Also perforated between tags.

	Description	Dimensions	Box	Ctn	Price
P60501	White Pinfeed (10 pt.)	2½" x 6¾"	1000	10BX	
P60503	White Pinfeed (10 pt.)	3" x 7¾"	1000	5BX	
P60502	Tyvek® Pinfeed	2½" x 6¾"	1000	10BX	
P60504	Tyvek® Pinfeed	3" x 7¾"	1000	10BX	
P60505	Two-Ply Glatfelter White, Pinfeed	3" x 7½"	1000	5BX	

Application:

Imprint your own copy and number series quickly and easily in your pinfeed printer.

Continuous Blank Interlocking Pinfeed Tags

Outdoor durable, high tear resistant and imprintable on laser or Dot Matrix

	Description	Dimensions	Box	Price
P60506	White Dura-laz	1½" x 12"	1000	

Shipping Envelope

	Description	Dimensions	Box	Price
P17411	Brown Kraft	3½" x 6½"	500	

Cloth Tag - Reinforced with Metal Eyelet

	White	Description	Size	Dimensions	Box	Ctn	Price
P11181		#5 Anchor Cloth	1	1¾" x 2¾"	1000	5BX	
P11185		#5 Anchor Cloth	5	2¾" x 4¾"	1000	5BX	

DuPont(TM), Tyvek® and Mylar® are trademarks or registered trademarks of DuPont or its affiliates.

INVENTORY TAGS

One-Part Inventory Tags

Printed black on both sides. Fiber patched and perforated. Duplicate numbered in red. 10 pt. stock color as indicated.

Inventory

Manila	Green	Orange	Description	Size	Dimensions	Box	Ctn	Price
			0000 - 0999	8	3 1/8" x 6 1/4"	1000	5BX	
			1000 - 1999	8	3 1/8" x 6 1/4"	1000	5BX	
	15552		2000 - 2999	8	3 1/8" x 6 1/4"	1000	5BX	
			3000 - 3999	8	3 1/8" x 6 1/4"	1000	5BX	
			4000 - 4999	8	3 1/8" x 6 1/4"	1000	5BX	
		15605	5000 - 5999	8	3 1/8" x 6 1/4"	1000	5BX	
		15606	6000 - 6999	8	3 1/8" x 6 1/4"	1000	5BX	
		15607	7000 - 7999	8	3 1/8" x 6 1/4"	1000	5BX	
			8000 - 8999	8	3 1/8" x 6 1/4"	1000	5BX	
			9000 - 9999	8	3 1/8" x 6 1/4"	1000	5BX	
			10000 - 10999	8	3 1/8" x 6 1/4"	1000	5BX	
			11000 - 11999	8	3 1/8" x 6 1/4"	1000	5BX	
			12000 - 12999	8	3 1/8" x 6 1/4"	1000	5BX	
			13000 - 13999	8	3 1/8" x 6 1/4"	1000	5BX	
			14000 - 14999	8	3 1/8" x 6 1/4"	1000	5BX	
			15000 - 15999	8	3 1/8" x 6 1/4"	1000	5BX	
			16000 - 16999	8	3 1/8" x 6 1/4"	1000	5BX	
			17000 - 17999	8	3 1/8" x 6 1/4"	1000	5BX	
			18000 - 18999	8	3 1/8" x 6 1/4"	1000	5BX	
			19000 - 19999	8	3 1/8" x 6 1/4"	1000	5BX	

3-Part Blank Manifold Tag

Blank Manifold with two white bond sheets, two carbons interleave, base of 10 pt. manila stock. Perforated. Numbered in red.

	Description	Size	Dimensions	Box	Ctn	Price
P15420	0000 - 0499	8	3 1/8" x 6 1/4"	500	10BX	
P15421	0500 - 0999	8	3 1/8" x 6 1/4"	500	10BX	
P15422	1000 - 1499	8	3 1/8" x 6 1/4"	500	10BX	
P15423	1500 - 1999	8	3 1/8" x 6 1/4"	500	10BX	
P15424	2000 - 2499	8	3 1/8" x 6 1/4"	500	10BX	
P15425	2500 - 2999	8	3 1/8" x 6 1/4"	500	10BX	
P15426	3000 - 3499	8	3 1/8" x 6 1/4"	500	10BX	
P15427	3500 - 3999	8	3 1/8" x 6 1/4"	500	10BX	
P15428	4000 - 4499	8	3 1/8" x 6 1/4"	500	10BX	
P15429	4500 - 4999	8	3 1/8" x 6 1/4"	500	10BX	

Front

Back

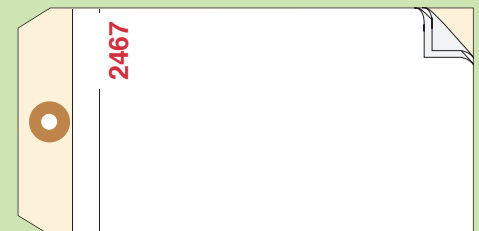

P15420 Series

CARBON INTERLEAF INVENTORY TAGS

Two-Part and Three-Part Manifold Inventory Tags help keep your inventory organized and controlled. Packaged 500/Box. Numbered in red up to 9999. White bond and one carbon with 10 pt. manila base stock. Printed black. 3-part has an additional pink middle bond and carbon.

2-Part Carbon Interleaf

	Description	Size	Box	Ctn	Price
P15100	0000 - 0499	8	500	10BX	
P15101	0500 - 0999	8	500	10BX	
P15102	1000 - 1499	8	500	10BX	
P15103	1500 - 1999	8	500	10BX	
P15104	2000 - 2499	8	500	10BX	
P15105	2500 - 2999	8	500	10BX	
P15106	3000 - 3499	8	500	10BX	
P15107	3500 - 3999	8	500	10BX	
P15108	4000 - 4499	8	500	10BX	
P15109	4500 - 4999	8	500	10BX	
P15110	5000 - 5499	8	500	10BX	
P15111	5500 - 5999	8	500	10BX	
P15112	6000 - 6499	8	500	10BX	
P15113	6500 - 6999	8	500	10BX	
P15114	7000 - 7499	8	500	10BX	
P15115	7500 - 7999	8	500	10BX	
P15116	8000 - 8499	8	500	10BX	
P15117	8500 - 8999	8	500	10BX	
P15118	9000 - 9499	8	500	10BX	
P15119	9500 - 9999	8	500	10BX	

3-Part Carbon Interleaf

	Description	Size	Box	Ctn	Price
P15320	0000 - 0499	8	500	10BX	
P15321	0500 - 0999	8	500	10BX	
P15322	1000 - 1499	8	500	10BX	
P15323	1500 - 1999	8	500	10BX	
P15324	2000 - 2499	8	500	10BX	
P15325	2500 - 2999	8	500	10BX	
P15326	3000 - 3499	8	500	10BX	
P15327	3500 - 3999	8	500	10BX	
P15328	4000 - 4499	8	500	10BX	
P15329	4500 - 4999	8	500	10BX	
P15330	5000 - 5499	8	500	10BX	
P15331	5500 - 5999	8	500	10BX	
P15333	6500 - 6999	8	500	10BX	
P15334	7000 - 7499	8	500	10BX	
P15335	7500 - 7999	8	500	10BX	
P15336	8000 - 8499	8	500	10BX	
P15337	8500 - 8999	8	500	10BX	
P15339	9500 - 9999	8	500	10BX	

Front View

P15100 Series
P15300 Series

Front View

P15320 Series
P15720 Series

Back View

CARBONLESS INVENTORY TAGS

Two-Part and Three-Part Carbonless Manifold Inventory Tags help eliminate transcribing errors, when more than one copy is required. Packaged 500/Box. Number series are printed in red up to 19999. White carbonless bond with 10 pt. manila base stock. Printed black. 3-part has an additional pink middle bond. See page 10 for copy.

2-Part Glatfelter Carbonless

	Description	Size	Box	Ctn	Price
P15300	0000 - 0499	8	500	10BX	
P15301	0500 - 0999	8	500	10BX	
P15302	1000 - 1499	8	500	10BX	
P15303	1500 - 1999	8	500	10BX	
P15304	2000 - 2499	8	500	10BX	
P15305	2500 - 2999	8	500	10BX	
P15306	3000 - 3499	8	500	10BX	
P15307	3500 - 3999	8	500	10BX	
P15308	4000 - 4499	8	500	10BX	
P15309	4500 - 4999	8	500	10BX	
P15310	5000 - 5499	8	500	10BX	
P15311	5500 - 5999	8	500	10BX	
P15312	6000 - 6499	8	500	10BX	
P15313	6500 - 6999	8	500	10BX	
P15314	7000 - 7499	8	500	10BX	
P15315	7500 - 7999	8	500	10BX	
P15316	8000 - 8499	8	500	10BX	
P15317	8500 - 8999	8	500	10BX	
P15318	9000 - 9499	8	500	10BX	
P15319	9500 - 9999	8	500	10BX	
P15380	10000 - 10499	8	500	10BX	
P15381	10500 - 10999	8	500	10BX	
P15382	11000 - 11499	8	500	10BX	
P15383	11500 - 11999	8	500	10BX	
P15384	12000 - 12499	8	500	10BX	
P15385	12500 - 12999	8	500	10BX	
P15386	13000 - 13499	8	500	10BX	
P15387	13500 - 13999	8	500	10BX	
P15388	14000 - 14499	8	500	10BX	
P15389	14500 - 14999	8	500	10BX	
P15390	15000 - 15499	8	500	10BX	
P15391	15500 - 15999	8	500	10BX	
P15392	16000 - 16499	8	500	10BX	
P15393	16500 - 16999	8	500	10BX	
P15394	17000 - 17499	8	500	10BX	
P15395	17500 - 17999	8	500	10BX	
P15396	18000 - 18499	8	500	10BX	
P15397	18500 - 18999	8	500	10BX	
P15398	19000 - 19499	8	500	10BX	
P15399	19500 - 19999	8	500	10BX	

3-Part Glatfelter Carbonless

	Description	Size	Box	Ctn	Price
P15720	0000 - 0499	8	500	10BX	
P15721	0500 - 0999	8	500	10BX	
P15722	1000 - 1499	8	500	10BX	
P15723	1500 - 1999	8	500	10BX	
P15724	2000 - 2499	8	500	10BX	
P15725	2500 - 2999	8	500	10BX	
P15726	3000 - 3499	8	500	10BX	
P15727	3500 - 3999	8	500	10BX	
P15728	4000 - 4499	8	500	10BX	
P15729	4500 - 4999	8	500	10BX	
P15730	5000 - 5499	8	500	10BX	
P15731	5500 - 5999	8	500	10BX	
P15732	6000 - 6499	8	500	10BX	
P15733	6500 - 6999	8	500	10BX	
P15734	7000 - 7499	8	500	10BX	
P15735	7500 - 7999	8	500	10BX	
P15736	8000 - 8499	8	500	10BX	
P15737	8500 - 8999	8	500	10BX	
P15738	9000 - 9499	8	500	10BX	
P15739	9500 - 9999	8	500	10BX	
P15740	10000 - 10499	8	500	10BX	
P15741	10500 - 10999	8	500	10BX	
P15742	11000 - 11499	8	500	10BX	
P15743	11500 - 11999	8	500	10BX	
P15744	12000 - 12499	8	500	10BX	
P15745	12500 - 12999	8	500	10BX	
P15746	13000 - 13499	8	500	10BX	
P15747	13500 - 13999	8	500	10BX	
P15748	14000 - 14499	8	500	10BX	
P15749	14500 - 14999	8	500	10BX	
P15750	15000 - 15499	8	500	10BX	
P15751	15500 - 15999	8	500	10BX	
P15752	16000 - 16499	8	500	10BX	
P15753	16500 - 16999	8	500	10BX	
P15754	17000 - 17499	8	500	10BX	
P15755	17500 - 17999	8	500	10BX	
P15756	18000 - 18499	8	500	10BX	
P15757	18500 - 18999	8	500	10BX	
P15758	19000 - 19499	8	500	10BX	
P15759	19500 - 19999	8	500	10BX	

SPECIALTY INVENTORY TAGS

P15500 Series - 2 Part Carbon
 P15300 Series - 2 Part Carbonless
 P15720 Series - 3 Part Carbonless

Front

Back

P15360 Series

Front

Back

2-Part Carbon Interleaf Inventory Tag with Transfer Tape

White bond, one carbon, 10 pt. manila base ply. Numbered in red. Printed black. Removable self-adhesive tape on back allows easy attachment to crates or cartons.

	Description	Size	Dimensions	Box	Ctn	Price
P15500	0000 - 0499	8	3 1/8" x 6 1/4"	500	10BX	
P15501	0500 - 0999	8	3 1/8" x 6 1/4"	500	10BX	
P15502	1000 - 1499	8	3 1/8" x 6 1/4"	500	10BX	
P15503	1500 - 1999	8	3 1/8" x 6 1/4"	500	10BX	
P15504	2000 - 2499	8	3 1/8" x 6 1/4"	500	10BX	
P15505	2500 - 2999	8	3 1/8" x 6 1/4"	500	10BX	
P15506	3000 - 3499	8	3 1/8" x 6 1/4"	500	10BX	
P15507	3500 - 3999	8	3 1/8" x 6 1/4"	500	10BX	
P15508	4000 - 4499	8	3 1/8" x 6 1/4"	500	10BX	
P15509	4500 - 4999	8	3 1/8" x 6 1/4"	500	10BX	
P15510	5000 - 5499	8	3 1/8" x 6 1/4"	500	10BX	
P15511	5500 - 5999	8	3 1/8" x 6 1/4"	500	10BX	
P15512	6000 - 6499	8	3 1/8" x 6 1/4"	500	10BX	
P15513	6500 - 6999	8	3 1/8" x 6 1/4"	500	10BX	
P15514	7000 - 7499	8	3 1/8" x 6 1/4"	500	10BX	
P15515	7500 - 7999	8	3 1/8" x 6 1/4"	500	10BX	
P15516	8000 - 8499	8	3 1/8" x 6 1/4"	500	10BX	
P15517	8500 - 8999	8	3 1/8" x 6 1/4"	500	10BX	
P15518	9000 - 9499	8	3 1/8" x 6 1/4"	500	10BX	
P15519	9500 - 9999	8	3 1/8" x 6 1/4"	500	10BX	

2-Part Carbonless Inventory Tag with Transfer Tape

White bond, 10 pt. manila base ply. Numbered in red. Printed black. Removable self-adhesive tape on back allows easy attachment to crates or cartons.

	Description	Size	Dimensions	Box	Ctn	Price
P15530	0000 - 0499	8	3 1/8" x 6 1/4"	500	10BX	
P15531	0500 - 0999	8	3 1/8" x 6 1/4"	500	10BX	
P15532	1000 - 1499	8	3 1/8" x 6 1/4"	500	10BX	
P15533	1500 - 1999	8	3 1/8" x 6 1/4"	500	10BX	
P15534	2000 - 2499	8	3 1/8" x 6 1/4"	500	10BX	
P15535	2500 - 2999	8	3 1/8" x 6 1/4"	500	10BX	
P15536	3000 - 3499	8	3 1/8" x 6 1/4"	500	10BX	
P15537	3500 - 3999	8	3 1/8" x 6 1/4"	500	10BX	
P15538	4000 - 4499	8	3 1/8" x 6 1/4"	500	10BX	
P15539	4500 - 4999	8	3 1/8" x 6 1/4"	500	10BX	
P15540	5000 - 5499	8	3 1/8" x 6 1/4"	500	10BX	
P15541	5500 - 5999	8	3 1/8" x 6 1/4"	500	10BX	
P15542	6000 - 6499	8	3 1/8" x 6 1/4"	500	10BX	
P15543	6500 - 6999	8	3 1/8" x 6 1/4"	500	10BX	
P15544	7000 - 7499	8	3 1/8" x 6 1/4"	500	10BX	
P15545	7500 - 7999	8	3 1/8" x 6 1/4"	500	10BX	
P15546	8000 - 8499	8	3 1/8" x 6 1/4"	500	10BX	
P15547	8500 - 8999	8	3 1/8" x 6 1/4"	500	10BX	
P15548	9000 - 9499	8	3 1/8" x 6 1/4"	500	10BX	
P15549	9500 - 9999	8	3 1/8" x 6 1/4"	500	10BX	

3-Part Carbonless Inventory Tag with Transfer Tape

White bond, 10 pt. manila base ply. Numbered in red. Printed black. Removable self-adhesive tape on back allows easy attachment to crates or cartons.

	Description	Size	Dimensions	Box	Ctn	Price
P15580	0000 - 0499	8	3 1/8" x 6 1/4"	500	10BX	
P15581	0500 - 0999	8	3 1/8" x 6 1/4"	500	10BX	
P15582	1000 - 1499	8	3 1/8" x 6 1/4"	500	10BX	
P15583	1500 - 1999	8	3 1/8" x 6 1/4"	500	10BX	
P15584	2000 - 2499	8	3 1/8" x 6 1/4"	500	10BX	
P15585	2500 - 2999	8	3 1/8" x 6 1/4"	500	10BX	
P15586	3000 - 3499	8	3 1/8" x 6 1/4"	500	10BX	
P15587	3500 - 3999	8	3 1/8" x 6 1/4"	500	10BX	
P15588	4000 - 4499	8	3 1/8" x 6 1/4"	500	10BX	
P15589	4500 - 4999	8	3 1/8" x 6 1/4"	500	10BX	

2-Part Glatfelter Inventory Tag, Carbonless

White carbonless bond with 10 pt. manila base ply. Numbered in red. Printed black.

	Description	Size	Dimensions	Box	Ctn	Price
P15360	0000 - 0499	8	3 1/8" x 6 1/4"	500	10BX	
P15361	0500 - 0999	8	3 1/8" x 6 1/4"	500	10BX	
P15362	1000 - 1499	8	3 1/8" x 6 1/4"	500	10BX	
P15363	1500 - 1999	8	3 1/8" x 6 1/4"	500	10BX	
P15364	2000 - 2499	8	3 1/8" x 6 1/4"	500	10BX	
P15365	2500 - 2999	8	3 1/8" x 6 1/4"	500	10BX	
P15366	3000 - 3499	8	3 1/8" x 6 1/4"	500	10BX	
P15367	3500 - 3999	8	3 1/8" x 6 1/4"	500	10BX	
P15368	4000 - 4499	8	3 1/8" x 6 1/4"	500	10BX	
P15369	4500 - 4999	8	3 1/8" x 6 1/4"	500	10BX	

PRODUCTION AND SAFETY TAGS

1-Part Control Tags

13 pt. stock as color indicated. Hole reinforced with fiber patch. Printed black.

	Description	Stock	No.	Size	Dimensions	Box	Ctn	Price
P15016	Inspected Tag	Yellow		5	2 ³ / ₈ " x 4 ³ / ₄ "	1000	5BX	
P15017	Rejected	Red		5	2 ³ / ₈ " x 4 ³ / ₄ "	1000	5BX	
P15018	Repair/Rework	Green Numbered	000 - 999	5	2 ³ / ₈ " x 4 ³ / ₄ "	1000	5BX	
P15019	Accepted	Blue		5	2 ³ / ₈ " x 4 ³ / ₄ "	1000	5BX	
P15020	Scrap	Yellow		5	2 ³ / ₈ " x 4 ³ / ₄ "	1000	5BX	
P15021	Accepted	Green		5	2 ³ / ₈ " x 4 ³ / ₄ "	1000	5BX	

2-Part Control Tags

10 pt. stock with a matching bond as indicated and carbon interleaf. Hole reinforced with fiber patch. Printed and numbered in black.

	Description	Stock	No.	Size	Dimensions	Box	Ctn	Price
P15022	Rejected	Red Base/ Pink Bond	000 - 499	5	2 ³ / ₈ " x 4 ³ / ₄ "	500	10BX	
P15023	Rejected	Red Base / Pink	500 - 999	5	2 ³ / ₈ " x 4 ³ / ₄ "	500	10BX	
P15024	Repair/Rework	Green Base / Lt.Gr	000 - 499	5	2 ³ / ₈ " x 4 ³ / ₄ "	500	10BX	
P15026	Accepted	Blue Base / Lt. Blue	000 - 499	5	2 ³ / ₈ " x 4 ³ / ₄ "	500	10BX	
P15027	Accepted	Blue Base / Lt. Blue	500 - 999	5	2 ³ / ₈ " x 4 ³ / ₄ "	500	10BX	
P15028	Scrap	Yellow Base /Canary	000 - 499	5	2 ³ / ₈ " x 4 ³ / ₄ "	500	10BX	
P15029	Scrap	Yellow Base /Canary	500 - 999	5	2 ³ / ₈ " x 4 ³ / ₄ "	500	10BX	

Application:

- Quality control
- Special requirement identification
- Production line tracking
- Record keeping assistance

INSPECTED

PART NUMBER _____

INSPECTION OK, APPROVED FOR USE _____

REPAIRS MADE DURING INSPECTION, APPROVED FOR USE _____

RETURN FOR REWORK AND/OR REPAIRS _____

RETURN TO VENDOR _____

COMMENTS _____

DATE _____ INITIALS _____

P15016

ACCEPTED

Customer _____

W.O. No. _____ Date _____

No. Pcs. _____ Material _____

Part No. _____ Ser. No. _____

Part Name _____

Inspector _____

Comments _____

P15019 - Blue
P15021 - Green

REPAIRABLE OR REWORK

CUSTOMER _____

JOB NO. _____ DATE _____

PART NO. _____ PART NAME _____

P.O. NO. _____ SER. NO. _____

NO. OF PIECES _____

DISPOSITION _____

INSP. _____ STAMP _____

REASON FOR REWORK (Use reverse side)

P15024

REJECTED

JOB NO. _____ P. O. NO. _____

PART NO. _____ SERIAL NO. _____

PART NAME _____

NO. OF PIECES REJECTED _____

REASON _____

INSPECTOR _____ DATE _____

P15017

SCRAP

PRODUCT PART NO. _____ DESCRIPTION _____

QTY./WT. _____ PRODUCT/JOB NO. _____ VENDOR _____

OPERATOR _____ DEPT./WORK CTR. NO. _____

REASON _____

DISPOSITION _____

CHARGE TO ACCT. NO. _____

INSPECTED BY _____ APPROVED BY _____

P15020

ACCEPTED

Customer _____

W.O. No. _____ Date _____

No. Pcs. _____ Material _____

Part No. _____ Ser. No. _____

Part Name _____

Inspector _____

Comments _____

P15026 / P15027

REPAIRABLE OR REWORK

CUSTOMER _____

JOB NO. _____ DATE _____

PART NO. _____ PART NAME _____

P.O. NO. _____ SER. NO. _____

NO. OF PIECES _____

DISPOSITION _____

INSP. _____ STAMP _____

REASON FOR REWORK (Use reverse side)

P15018

REJECTED

JOB NO. _____ P. O. NO. _____

PART NO. _____ SERIAL NO. _____

PART NAME _____

NO. OF PIECES REJECTED _____

REASON _____

INSPECTOR _____ DATE _____

P15022 / P15023

SCRAP

PRODUCT PART NO. _____ DESCRIPTION _____

QTY./WT. _____ PRODUCT/JOB NO. _____ VENDOR _____

OPERATOR _____ DEPT./WORK CTR. NO. _____

REASON _____

DISPOSITION _____

CHARGE TO ACCT. NO. _____

INSPECTED BY _____ APPROVED BY _____

P15028 / P15029

PRODUCTION AND SAFETY TAGS

Control Tags

13 pt. stock as color indicated. Blank or printed black.

	Description	Stock	Size	Dimensions	Pkg	Box	Ctn	Price
P14527	3 Color Process Control		7	2 ⁷ / ₈ " x 5 ³ / ₄ "	50			
P15033	Scrap Tag	Yellow	5	2 ³ / ₈ " x 4 ³ / ₄ "		1000	10BX	
P15034	Return To Stock Tag	Yellow	5	2 ³ / ₈ " x 4 ³ / ₄ "		1000	10BX	
P15035	Tested Tag	Dk Green	5	2 ³ / ₈ " x 4 ³ / ₄ "		1000	10BX	
P15036	Inspected Tag	Dk Green	5	2 ³ / ₈ " x 4 ³ / ₄ "		1000	10BX	
P15038	Sample Tag	White	5	2 ³ / ₈ " x 4 ³ / ₄ "		1000	10BX	

Metal Rim Tags

Heavy stock and smooth writing surface. Aluminum rims prevent bending. Tags are white with knotted string attached.

	Description	Box	Ctn	Price
P14312	7/8" diameter	500	12BX	
P14313	1 3/8" diameter	500	12BX	
P14314	1 1/2" diameter	500	12BX	
P14315	1 7/8" diameter	500	12BX	

Application:

- Property identification
- Property tracking
- Business assets protection
- Accounting and insurance procedure assistance

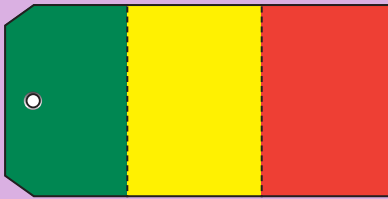

P14527



P15035

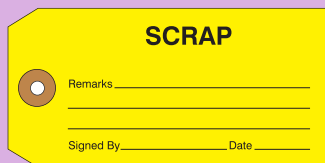

P15033



P15036

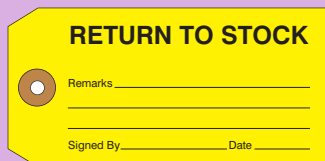

P15034

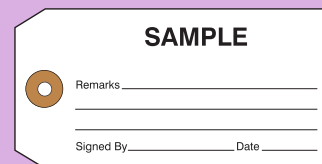

P15038

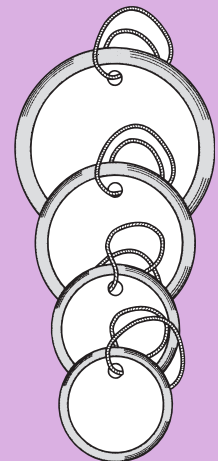

Metal Rim Tags

PRODUCTION AND SAFETY TAGS

2 Part Colored Tags

Colored Bond with 10 pt. colored base, carbon interleaf, hole reinforced with fiber patch. Printed black.

	Description	Numbering	Size	Dimensions	Box	Ctn	Price
P15045	Parts Tag - Lt green bond with dk. green base ply	0000 - 0499	8	3 1/8" x 6 1/4"	500	10BX	
P15046	Move Ticket - White bond with orange base ply	0000 - 0499	8	3 1/8" x 6 1/4"	500	10BX	
P15047	Non-Conforming Material Tag - Pink bond with red base ply	0000 - 0499	8	3 1/8" x 6 1/4"	500	10BX	

Safety Tag

	Description	Size	Dimensions	Box	Ctn	Price
P15050	Danger - 10 pt. White Vinyl. Printed black and red	8	3 1/8" x 6 1/4"	500	10BX	

Poly-Tag Pouches - prewired

Clear plastic front attached to durable paper stock as indicated. Adhesive strip for sealing in contents. Reinforcing patch and metal eyelet. Pre-wired.

	Description	Size	Dimensions	Box	Ctn	Price
P17500	White CSU		5" x 9 1/2"	500	2BX	
P17501	White Permafiber		5" x 9 1/2"	500	2BX	
P17502	Yellow Permafiber		5" x 9 1/2"	500	2BX	

PARTS TAG

WARRANTY
 REPAIR
 RETURN

NAME _____ PHONE # _____

ADDRESS _____ CITY _____ ST _____ ZIP _____

PART DESCRIPTION _____ PART / SERIAL # _____

MANUFACTURER _____ AUTHORIZED BY _____

PROBLEM _____

P15045

MOVE TICKET

DATE _____ JOB NUMBER _____ ISSUED BY _____

PART NUMBER _____ REWORK _____ DESCRIPTION _____

MOVE FROM _____ MOVE TO _____

COMMENTS _____

P15046

NON-CONFORMING MATERIAL

DATE _____ PART # DESCRIPTION _____

REASON FOR REJECTION _____

QTY REJECTED _____ REJECTED BY _____

SORT
 SCRAP
 RETURN TO SUPPLIER
 RETURN TO STOCK
 REPAIR
 REWORK

P15047

Poly Pouches

POLY FILM HERE
with 3 heat seal seams

EXPOSE ADHESIVE, REMOVE LINER TO EXPOSE ADHESIVE, RE
 ER TO EXPOSE ADHESIVE, REMOVE LINER TO EXPOSE ADH
 NOW EXPOSE Q1 TO EXPOSE Q1 TO EXPOSE Q1 TO EXPOSE Q1
 IVE, REMOVE LINER TO EXPOSE ADHESIVE, REMOVE LINER
 EXPOSE ADHESIVE, REMOVE LINER TO EXPOSE ADHESIVE, RE

P15050

Front

Back

DANGER

DO NOT REMOVE THIS TAG
UNLESS AUTHORIZED

DO NOT OPERATE

SEE OTHER SIDE

DANGER

DO NOT OPERATE

SIGNED BY: _____

DATE: _____

RETAIL - BLANK MARKING TAGS

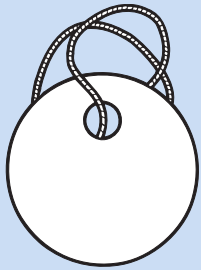

Circular Merchandise Tags

Circular Merchandise Tags - Knotted String

	Description	Box	Ctn	Price
P12108	1 3/4" diameter, white	1000	20BX	
P12109	1 3/8" diameter, white	1000	20BX	

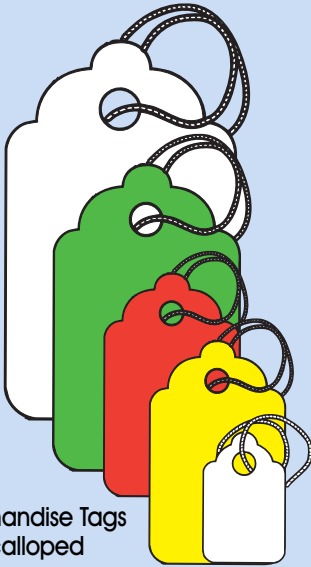

Merchandise Tags
Scalloped

Merchandise Tags, Scalloped - 13 Pt. Knotted String/Variou Lengths

White	Yellow	Red	Green	Dimensions	Box	Ctn	Price
P12200				2" x 3 1/4"	1000	12BX	
P12201	12421	12441	12451	1 3/4" x 2 7/8"	1000	12BX	
P12202				1 7/8" x 2 3/8"	1000	12BX	
P12203				1 1/4" x 1 7/8"	1000	12BX	
P12204				1 1/8" x 1 3/4"	1000	12BX	
P12205	12425	12445	12455	1 5/8" x 1 1/2"	1000	12BX	
P12206				7/8" x 1 1/4"	1000	12BX	
P12207				3/4" x 1 1/8"	1000	12BX	
P12211				5/8" x 1 5/16"	1000	12BX	

Jewelry Tags - White stock, 6" knotted rayon string

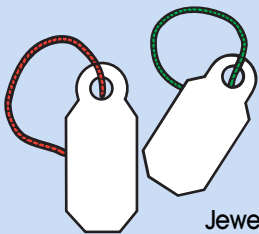

Jewelry Tags

	Description	Box	Price
P13045	7/16" x 3/4" with Red String	1000	
P13055	1/4" x 1 1/16" with Red String	1000	
P13085	3/8" x 1 3/16" with Red String	1000	
P13095	7/16" x 1 5/16" with Red String	1000	
P13165	5/16" x 1 1/16" with Green String	1000	

Jewelry Labels

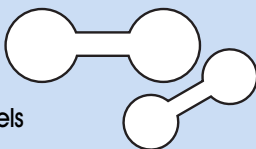

Jewelry Labels

	Description	Box	Price
P13206	5/16" x 1 1/2" Kromekote Ring	1000	
P13226	7/16" x 1 1/8" Kromekote Ring	1000	
P13406	5/16" x 1 1/2" Tyvek® Ring	1000	
P13426	7/16" x 1 1/8" Tyvek® Ring	1000	

RETAIL - GARMENT MARKING TAGS

Button Tags - 10 pt. C1S white stock printed black. Perforated.

	Description	Box	Ctn	Price
P99599	1 3/4" x 2 7/8"	1000	24BX	

P99599

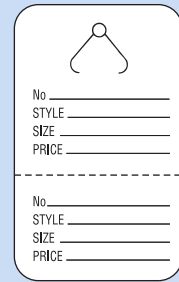

Couponsed Garment Tags - Unstrung

Printed black on colored stock as indicated. Perforated.

	Description	Box	Ctn	Price
P96345	1 3/4" x 2 7/8" - White	1000	12BX	
P96352	1 3/4" x 2 7/8" - Yellow	1000	12BX	
P96362	1 3/4" x 2 7/8" - Lt. Blue	1000	12BX	
P96372	1 3/4" x 2 7/8" - Pink	1000	12BX	
P96382	1 3/4" x 2 7/8" - Lilac	1000	12BX	
P96392	1 3/4" x 2 7/8" - Red	1000	12BX	
P96402	1 3/4" x 2 7/8" - Grey	1000	12BX	
P96412	1 3/4" x 2 7/8" - Dk. Green	1000	12BX	
P96422	1 3/4" x 2 7/8" - Dk. Blue	1000	12BX	
P96432	1 3/4" x 2 7/8" - Beige	1000	12BX	
P96442	1 3/4" x 2 7/8" - Orange	1000	12BX	
P96452	1 3/4" x 2 7/8" - Lt. Green	1000	12BX	

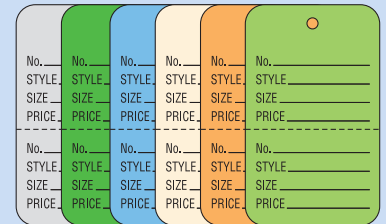
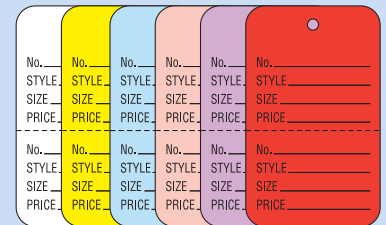

Garment Tags

Small Couponsed Garment Tags - Unstrung

Printed black on colored stock. Perforated.

	Description	Box	Ctn	Price
P99500	1 1/4" x 1 7/8" - White	1000	12BX	
P99501	1 1/4" x 1 7/8" - Grey	1000	12BX	
P99503	1 1/4" x 1 7/8" - Red	1000	12BX	
P99505	1 1/4" x 1 7/8" - Lt. Blue	1000	12BX	
P99507	1 1/4" x 1 7/8" - Dk. Green	1000	12BX	
P99509	1 1/4" x 1 7/8" - Beige	1000	12BX	
P99511	1 1/4" x 1 7/8" - Pink	1000	12BX	
P99513	1 1/4" x 1 7/8" - Orange	1000	12BX	
P99515	1 1/4" x 1 7/8" - Lilac	1000	12BX	
P99517	1 1/4" x 1 7/8" - Yellow	1000	12BX	
P99519	1 1/4" x 1 7/8" - Dk. Blue	1000	12BX	
P99523	1 1/4" x 1 7/8" - Lt. Green	1000	12BX	



Small Garment Tags

Quickly and easily attach garment tags with our mini TACH-IT® 2 gun and assortment of needles and security ties, See page 33 for details.

RETAIL - BUSINESS CONTROL TAGS

Layaway Tags - Strung

Description	Dimensions	Box	Ctn	Price
P15040 000 - 499 Manila Stock. Printed black on both sides. Perforated, patched. Triplicate numbered in red. Looped string attached.	3 1/8" x 7"	500	10BX	

Repair Tags - Strung

Description	Size	Dimensions	Box	Ctn	Price
P15030 000 - 999 Manila stock, printed black on one side. Perforated, patched with looped string. Duplicate numbered in red.	6	2 5/8" x 5 1/4"	1000	5BX	
P15032 1000 - 1999	6	2 5/8" x 5 1/4"	1000	5BX	

Alteration Tags

Description	Size	Dimensions	Box	Ctn	Price
P15010 000 - 499 Manila stock, printed black on both sides. Perforated and patched. Duplicate numbered in red with button slot.	7	2 7/8" x 5 3/4"	500	10BX	
P99701 Alteration/Button Slot Manila stock, printed black both sides. Perforated, patched, button slot. Duplicate numbered in red.	8	3 1/8" x 6 1/4"	1000	5BX	
P99704 Alteration, strung White stock, printed brown. Perforated, matching patch, looped string. Duplicate numbered in red.	8	3 1/8" x 6 1/4"	1000	5BX	

Front P15040

LAY-AWAY TICKET NO. **111**

Date _____

Name _____

Address _____

Article _____ Sold by _____

Retail Price _____ Tax _____ Total _____

Read Price _____

Tax _____

Total _____

TICKET NO. **111**

Name _____

Address _____

Article _____ Clerk No. _____

PAYMENTS MADE				
Date	Sub. By	Amount	Balance	Rec'd By

CUSTOMER'S IDENTIFICATION STUB

LAY-AWAY TICKET NO. 111

This stub is to be retained until final payment is made and surrendered upon receipt of merchandise. If merchandise is not fully paid for and called for on or before _____ it will be returned to stock unless special arrangements are made.

SOLD BY _____

Back

1. I understand that this merchandise will be held for me in the Lay-Away Dept and I agree to pay the balance due by _____.

2. I agree to pay \$ _____ Every _____.

3. I understand that if the merchandise is not fully paid for and called for on or before _____ it will be returned to stock unless special arrangements are made.

SP _____

MFR _____

LOT NO. _____ DATE REC'D _____

REMARKS _____

PAYMENTS MADE				
Date	Sub. By	Amount	Balance	Rec'd By

P15030

P15032

268 Date _____

Name _____

Address _____

Article _____

Date Promised _____

Price _____

Work to be done _____

COUPON NO. _____ DATE PROMISED _____

268

Article _____

Price _____

Front P15010

Back

No. **001** Date _____

Name _____

Address _____

Garment _____

Am't of Sale _____

Am't Paid _____

Price _____

Bal. Due C.O.D. Charge _____

Wanted _____

Will Call _____ Deliver _____

Salesperson _____

NOTE ALTERATIONS ON REVERSE SIDE

CUSTOMER'S CLAIM CHECK

No. **001** Date _____

Garment _____

Salesperson _____ Am't Due _____

NO GOODS DELIVERED W/ THOUT THIS CHECK

Front P99701

Back

000001

ALTERATION TAG

STATE ALTERATIONS ON BACK

Date _____

Name _____

Address _____

Garment _____

Price Tax Alt. Total _____

Sold by _____ Paid _____

When To be Done Will Call Due _____

Remarks _____

(OWNER)

000001 Date _____

Garment _____

Price Tax Alt. Total _____

Sold by _____ Paid _____

When Finished Due _____

NO GOODS DELIVERED WITHOUT THIS CHECK

COAT

Shoulders _____ Length _____

Sleeves _____ Buttons _____

Collar _____ Lining _____

Cuffs _____ More _____

Pel _____ Buttons _____

Shoulders _____ Shoulder _____

Chest _____ Width _____

Waist _____ Let out _____

Take in _____ Stays _____

VEST

Chest _____

Waist _____

TROUSERS

Waist _____ Thigh _____

Length _____ Knee _____

Bottom _____ Fin. Hem _____

With Cuffs _____ Without Cuffs _____

P99704

ALTERATION

No. **222862**

Date _____

Name _____

Address _____

Garment _____

Salesperson _____ Dept. _____

Will Call _____ Send _____

CHARGE CASH C.O.D.

Amount of Sale _____

Tax _____

Alteration Charge _____

Total _____

Deposit _____

Balance Due _____

NOTE ALTERATIONS ON REVERSE SIDE

CUSTOMER'S CLAIM CHECK

No. **222862** Am't of Sale _____

To Be Ready _____ Tax _____

A.M. P.M. All. Charge _____

Dept. _____ Total _____

Deposit _____

Balance Due _____

Salesperson _____

NO GARMENTS DELIVERED WITHOUT THIS CHECK

RETAIL - CARPET AND FURNITURE TAGS

Description			Dimensions	Box	Ctn	Price
P72501	Carpet Remnant	10 pt. C1S white stock, printed red.	5 1/4" x 7"	500	5BX	
P72504	Carpet Roll	10 pt. C1S white stock, printed red, metal reinforced eyelet.	5 1/4" x 7"	500	5BX	
P72507	No-Rip Carpet Roll	Tyvek® stock, printed red, metal reinforced eyelet.	5 1/4" x 7"	500	5BX	
P99707	Inventory Record Tag	Manila stock, printed black.	2 1/8" x 5 3/4"	1000	5BX	

Furniture Tags

Description			Dimensions	Box	Ctn	Price
P15083	Blue Price	Lt. Blue stock. Blue ink on both sides, blue rayon knotted string.	2 1/8" x 3 1/8"	500	22BX	
P15084	Ivory Price	Ivory stock. Printed red and brown, red knotted string.	2 1/8" x 3 1/8"	500	22BX	
P15086	Utility	Buff stock. Printed brown, brown knotted string.	2" x 3"	500	22BX	



P72501



P72504
P72507

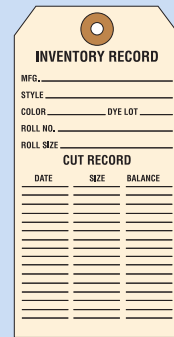

P99707

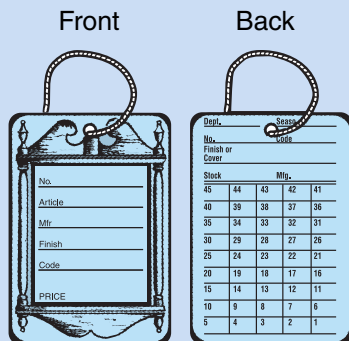

P15083



P15084



P15086

RETAIL - SALE TAGS

Retail Sale Tags - Large

	Description	Dimensions	Box	Ctn	Price
P15088	Sale	White stock, printed red. 3½" knife slit.	5" x 7"	500	5BX
P72202	Was/Now	White stock, printed red. 3½" knife slit.	4" x 8"	500	4BX
P72203	As Advertised	White stock, printed red. 3½" knife slit.	4" x 8"	500	4BX
P72209	Sale	Fluorescent red stock, printed red. 3½" knife slit.	4" x 8"	500	4BX
P72110	Warehouse	White stock, printed orange & blue. 3½" knife slit.	4" x 8"	500	4BX
P72324	Sale	White stock, printed red & black. 3½" knife slit.	9½" x 6½"	250	10BX



P15088

P72202



P72203

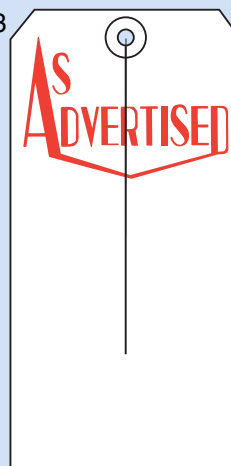

P72209



P72110



P72324

RETAIL - SALE TAGS

Retail Sale Tags - Medium

Description	Size	Dimensions	Box	Ctn	Price
P15220 Special Sale White stock, printed red. 3½" knife slit.	8	3½" x 6¼"	500	10BX	
P15223 Special Sale White stock, printed red. 3½" knife slit.	6	2½" x 4¼"	500	10BX	
P72326 Mfr. Suggested Retail White stock, printed red. 3½" knife slit.	8	3½" x 6¼"	500	10BX	
P72405 Special Sale White stock, printed red & blue. 3½" knife slit.	6	2½" x 4¼"	500	10BX	
P72407 Reg Price/Our Price White stock, printed red. 3½" knife slit.	8	3½" x 6¼"	500	10BX	
P72408 Sale Sale Sale White stock, printed red & yellow. 3½" knife slit.	6	2½" x 4¼"	500	10BX	

Retail Sale Tags - Small

Description	Dimensions	Box	Ctn	Price
P15208 Sale Yellow stock, printed red, yellow knotted string.	1¾" x 2¾"	1000	22BX	
P15251 Special White stock, printed red, red knotted string.	1¾" x 2¾"	500	22BX	



P15220



P15223



P72326



P72405



P72407



P72408



P15208

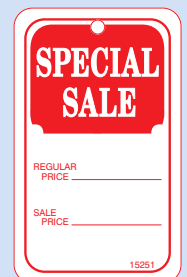

P15251

RETAIL - SALE TAGS

	Description		Dimensions	Box	Ctn	Price
P72420	Blank Tag	White stock, 3½" knife slit.	4½" x 6½"	500	10BX	
P72422	Anniversary Sale Tag	Lt. blue stock, printed black, 3½" knife slit.	4½" x 6½"	500	10BX	
P72423	Winter Sale Tag	White stock, printed blue, 3½" knife slit.	4½" x 6½"	500	10BX	
P72424	Spring Sale Tag	White stock, printed green, 3½" knife slit.	4½" x 6½"	500	10BX	
P72425	Summer Sale Tag	White stock, printed red, 3½" knife slit.	4½" x 6½"	500	10BX	
P72426	Fall Savings Tag	White stock, printed orange, 3½" knife slit.	4½" x 6½"	500	10BX	
P72427	Going Out of Business Tag	Buff stock, printed brown, 3½" knife slit.	4½" x 6½"	500	10BX	

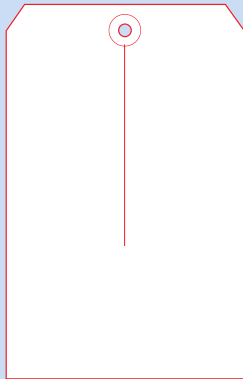

P72420



P72422



P72423



P72424



P72425

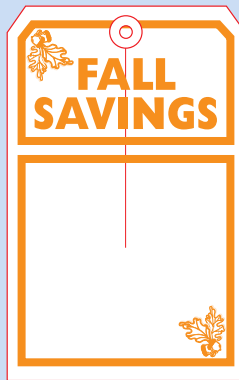

P72426

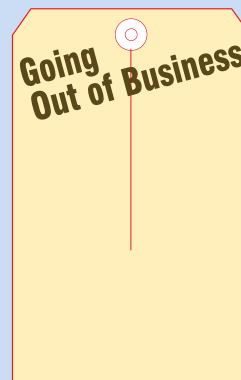

P72427

RETAIL - SALE TAGS

	Description		Dimensions	Box	Ctn	Price
P72429	Grand Opening Tag	White stock, printed blue, 3½" knife slit.	4¼" x 6½"	500	10BX	
P72430	Sale Tag	White stock, printed red & blue, 3½" knife slit.	4¼" x 6½"	500	10BX	
P72431	Holiday Tag	White stock, printed red & green, 3½" knife slit.	4¼" x 6½"	500	10BX	
P95705	Tree Sale Tag	White Tyvek® stock, printed black, numbered 000-999, pre-wired	2¾" x 4¾"	1000	5BX	
P95708	Tree Type Tag	White Tyvek® stock, printed black, numbered 000-999, pre-wired	3½" x 6¼"	1000	5BX	

Newest Edition to our Catalog

Popular Sales Theme
Enhances your Sales

Eye Catching

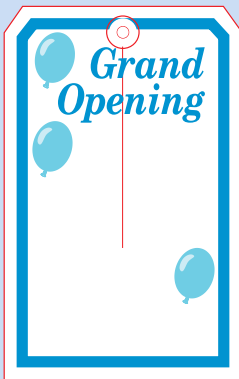

P72429



P72430



P72431

 A rectangular tag with a white background. It features a black silhouette of a tree on the left and a red circular fastener at the top center. The word "00001" is printed in black. Below the tree, there are fields for "Type" and "Height". A large black dollar sign (\$) is in a white box. At the bottom, there are fields for "TAG No.", "Type", "Height", and "PRICE \$".

P95705

 A rectangular tag with a white background. It features a black silhouette of a tree on the left and a red circular fastener at the top center. The word "00001" is printed in black. Below the tree, there are checkboxes for "Fir", "Pine", "Spruce", and "Other", each followed by a line for text. Below these is a field for "Height" followed by "Ft.". At the bottom, there is a field for "Price \$".

P95708

RETAIL - SPECIALIZED TAGS

General Merchandise Tags

Description	Size	Dimensions	Box	Ctn	Price
P72303 I'm Sold But White stock, printed red, 3/2" knife slit.	8	3 1/8" x 6 1/4"	500	10BX	
P72305 Out of Stock Tag Red stock, printed black.	5	2 3/8" x 4 3/4"	500	5BX	
P95886 Rifle ID Manilla stock, printed brown, pre-strung.	3	1 7/8" x 3 3/4"	500	20BX	

Sold / Hold Tags with 3 1/2" slit

Description	Size	Dimensions	Box	Ctn	Price
P15161 Sold 13 pt. red stock, printed black, 3/2" knife slit.	5	2 3/8" x 4 3/4"	500	10BX	
P15165 Sold 13 pt. white stock, printed red, 3/2" knife slit.	5	2 3/8" x 4 3/4"	500	10BX	
P72301 Sold 10 pt. red stock, printed black, 3/2" knife slit.	5	2 3/8" x 4 3/4"	1000	5BX	
P72302 Sold 10 pt. white stock, printed red, 3/2" knife slit.	5	2 3/8" x 4 3/4"	1000	5BX	
P15166 Hold 10 pt. white stock, printed blue, 3/2" knife slit.	5	2 3/8" x 4 3/4"	500	10BX	



P72305

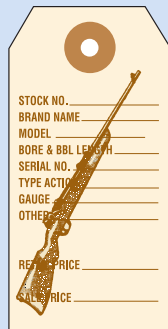

P95886

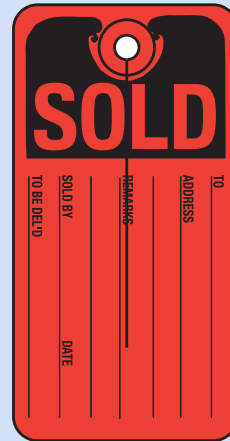

P15161



P15165



P72303



P72301



P72302

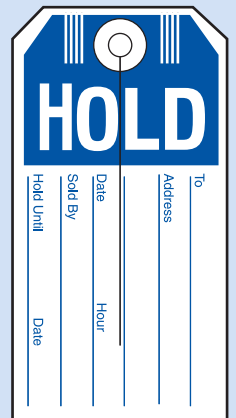

P15166

AUTOMOTIVE TAGS

Auto I.D. Tags

	Description	Dimensions	Box	Ctn	Price
P55500	000-999 Red/Green	5¼" x 6½"	1000	5BX	
P55501	1000-1999 Red/Green	5¼" x 6½"	1000	5BX	
P55502	2000-2999 Red/Green	5¼" x 6½"	1000	5BX	
P55503	3000-3999 Red/Green	5¼" x 6½"	1000	5BX	
P55504	4000-4999 Red/Green	5¼" x 6½"	1000	5BX	
P55505	5000-5999 Red/Green	5¼" x 6½"	1000	5BX	
P55506	6000-6999 Red/Green	5¼" x 6½"	1000	5BX	
P55507	7000-7999 Red/Green	5¼" x 6½"	1000	5BX	
P55508	8000-8999 Red/Green	5¼" x 6½"	1000	5BX	
P55509	9000-9999 Red/Green	5¼" x 6½"	1000	5BX	

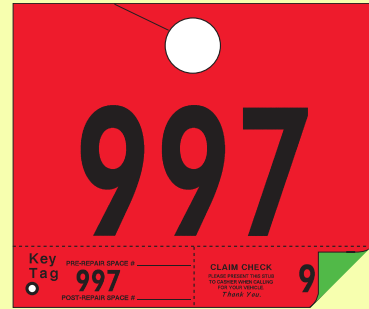

Auto I.D. Tags

Paper Key Tags with Rings

	Description	Dimensions	Box	Ctn	Price
P55520	White stock, printed black	1⅜" x 2¾"	1000	10BX	
P55521	Yellow stock, printed black	1⅜" x 2¾"	1000	10BX	
P55522	Red stock, printed black	1⅜" x 2¾"	1000	10BX	
P55523	Lt. Blue stock, printed black	1⅜" x 2¾"	1000	10BX	
P55524	Lt. Green stock, printed black	1⅜" x 2¾"	1000	10BX	
P55525	Orange stock, printed black	1⅜" x 2¾"	1000	10BX	

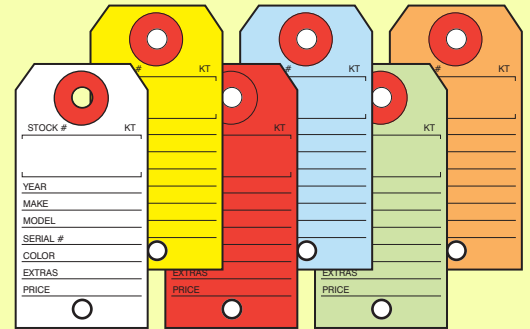

Paper Key Tags with Rings

Key Rings

	Description	Bag	Ctn	Price
P18310	⅞" Key Rings	250		

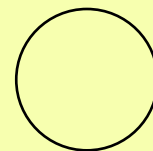

Key Ring

AUTOMOTIVE TAGS

P55560 Front - Blue

HOLD

Date _____ Hold By _____

To _____

Address _____

Hold Until _____

P55560 Back - Red

SOLD

Date _____ Sold By _____

To _____

Address _____

Remarks _____

P55550

WAS

\$ _____

NOW

\$ _____

P55551

Hold/Sold Tag

	Description	Dimensions	Box	Ctn	Price
P55560	White Stock 2 tags in one, Hold on one side, Sold on other side reinforced at both ends, knife slit between. Tag can be slipped over other tags, wiper, mirror, or otherwise hung.	4" x 6"	500	10BX	

Large Was/Now Tag

	Description	Dimensions	Box	Ctn	Price
P55550	Fluorescent Red Stock Printed black on one side Back side blank for additional uses, diecut for hanging	8.5" x 11"	250		

Large Blank Tag

	Description	Dimensions	Box	Ctn	Price
P55551	Fluorescent Green Stock Bright color to attract attention, diecut for hanging	8.5" x 11"	250		

ENTERTAINMENT TAGS

Ideal for use in admission at:

- parks
- water parks
- fairs
- public occasions
- other events

Wristickets - Tyvek®

Colorful wristbands constructed of Tyvek®, with tamper-proof security die cut.

	Description	Ink	Dimensions	Box	Price
PWTWAVE	000 - 999	Blue	.75"x10"	1000	
PWTFEET	000 - 999	Purple	.75"x10"	1000	
PWTFUN	000 - 999	Fl. Pink	.75"x10"	1000	
PWTFLAG	000 - 999	Red	.75"x10"	1000	
PWTVIP	000 - 999	Orange	.75"x10"	1000	
PWTSCHOOL	000 - 999	Fl. Pink	.75"x10"	1000	
PWTSTPYEL	000 - 999	Yellow	.75"x10"	1000	
PWTSTPRED	000 - 999	Red	.75"x10"	1000	
PWTSTPGRN	000 - 999	Green	.75"x10"	1000	
PWTSTPBLU	000 - 999	Blue	.75"x10"	1000	
PWTFLRPNK	000 - 999	Fl. Pink	.75"x10"	1000	
PWTFLRGRN	000 - 999	Fl. Green	.75"x10"	1000	

LIMITED QUANTITIES OF 1" X 10" WILL BE SHIPPED FIRST IF AVAILABLE

PWTWAVE



PWTSTPYEL



PWTSTPRED



PWTSTPGRN



PWTSTPBLU



PWTSCHOOL

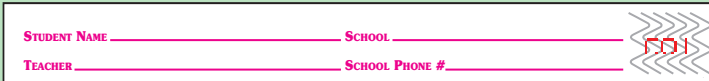

PWTFEET



PWTFLRPNK



PWTFLRGRN



PWTVIP



PWTFUN



PWTFLAG



HOSPITALITY PARKING -VALET TAGS

Valet Parking/Claim Check/Tag

	Description	Dimensions	Box	Ctn	Price
P18940	White Stock 7.5 pt. uncoated stock, Printed black Black numbering sequence is 0001 to 1000 Die cut for hanging	5"x9½"	1000	1BX	
P18941	White Stock 100# uncoated stock, Printed black Red numbering sequence is 000 to 999	6¾"x2½"	1000	10BX	
P18942	White Stock 13 pt. CSU stock, Printed black Red numbering sequence is 000 to 999 Die cut for hanging	9½"x2¾"	1000	5BX	
P60310	0000 - 0999 10 pt. uncoated white stock, Printed blue with red numbers. Two perforations, die cut for hanging.	2½" x 10½"	1000	5BX	
P60330	00000 - 00999 10 pt. uncoated white stock. Printed green and yellow with triplicate black numbers. Two perforations, die cut for hanging.	2½" x 12"	1000	5BX	



P18940



P18941

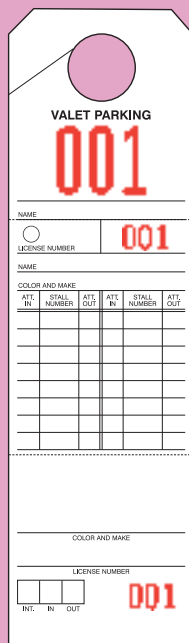

P18942

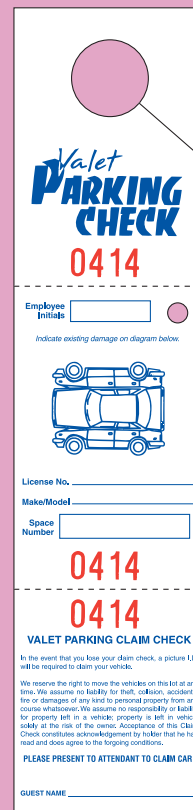
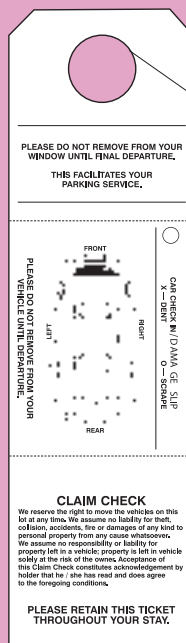

P60310

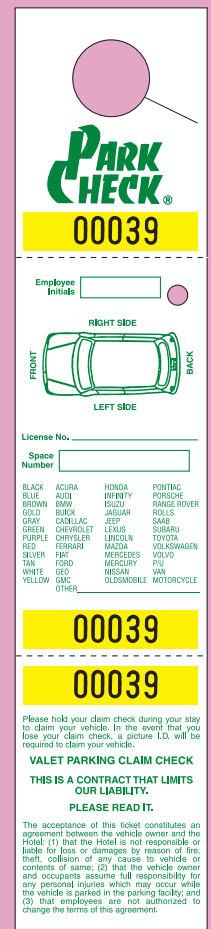

P60330

HOSPITALITY BAGGAGE TAGS

Bag Identification Tags

	Description	Dimensions	Box	Ctn	Price
P18950	White Stock 10 pt. uncoated stock, Black Ink, red numbering sequence is 0001 to 9999, knotted string attached.	2 1/2" x 4 1/4"	1000	5BX	
P60300	0000 - 0999 Perforated numbered guest check. Manifold construction with six matching numbers. Yellow tag and label stock with elastic string. Printed black.	2 1/2" x 6 1/2"	1000	5BX	
P60320	00000 - 00999 Constructed of tear-proof durable stock, this unique baggage tag ensures easy and reliable identification. Printed green on white stock with duplicate black numbering.	1 1/2" x 11"	1000	5BX	

Application:
six matching numbers for up to six pieces of luggage.

Application: Interlocking bag tag system attaches to a single piece of luggage.

●

LUGGAGE TAG

Guest Name _____

Room No. _____







Date In _____

Date Out _____

No. 0001

P18950

P60300

	0001
	0001
	0001
	0001
	0001
	0001

●

NAME: _____

ROOM NO: _____

NO. BAGS: _____

Present to Guest Representative upon registration. Retain the Check.

BAGS I.D. _____

0001

Present to Guest Representative upon registration. Retain this Check.

BAGS I.D. _____

0001

●

In consideration of the free storage of the property covered by this check, the owner or person depositing same agrees: This establishment is not liable for the theft, loss, damage or destruction of the property in the absence of gross negligence on the part of this establishment or its employees.

If the property is not called for within ten (10) days, this establishment shall have the right to assess reasonable charges for its storage and after sixty (60) days, shall have the right to sell the property according to law.



Stored items are labeled for easy identification and retrieval.

In consideration of the free storage of the property covered by this check, the owner or person depositing same agrees: This establishment is not liable for the theft, loss, damage or destruction of the property in the absence of gross negligence on the part of this establishment or its employees. If the property is not called for within ten (10) days, this establishment shall have the right to assess reasonable charges for its storage and after sixty (60) days, shall have the right to sell the property according to law.

●

Guest Name _____

Room # _____

Checked By _____ Date _____

00162

00162

Present This Stub To Claim Your Bag

The Hotel is not liable for loss or damage to the property as a result of fire, theft, ordinary or gross negligence, or otherwise, unless it appears that the loss or damage was caused by willful act or misappropriation on the part of the Hotel or its employees.

P60320

HOSPITALITY BAGGAGE TAGS

Baggage ID Tag w/Transfer Tape

		Description	Size	Dimensions	Box	Ctn	Price
P18951	White Stock	10 pt. C1S, printed blue, red numbering sequence is 000 to 999, transfer tape on back		1 1/4" x 10 1/2"	1000	5BX	

Cohesive Bag Tag

		Description	Size	Dimensions	Box	Ctn	Price
P18952	White Stock	9 pt. cohesive stock, printed blue, red numbering sequence is 000-999		1 1/2" x 11"	1000	5BX	

Baggage Claim Check Tags - Knotted String

		Description	Size	Dimensions	Box	Ctn	Price
P18953	White Stock - English	13 pt. uncoated white, printed blue, red numbering sequence is 000 to 999	6	2 5/8" x 5 1/4"	1000	5BX	
P18954	White Stock - Spanish	13 pt. uncoated white, printed blue, red numbering sequence is 000 to 999	6	2 5/8" x 5 1/4"	1000	5BX	

P18951

001 Name _____ Room _____ Pieces _____ Date Left _____ Date to Pick-up _____	BAGGAGE ID TAG	001 Claim Check
---	-----------------------	---------------------------

This check is subject to the following conditions:
 1. Property may be delivered to any person presenting check, but will not be delivered without check.
 2. Owner(s) of this property assumes all risk of damage by fire, water, theft or other causes.
 3. Liability for above risks is limited to amount set by law unless a separate agreement has been made.
 4. Baggage left an unreasonable length of time will be disposed of in accordance with the law.

P18952

Present This stub to Claim Your Bag 001 100 The holder is not liable for loss or damage to property if the check is not presented at the time of check-out, unless it was caused by willful act or negligence on the part of the holder of this stub.	BAGGAGE IDENTIFICATION TAG	001
NAME: _____ ROOM #: _____ CHECKED BY: _____ PIECES: _____ DATE LEFT: _____ DATE TO PICKUP: _____		

P18953

18953
Name _____
Room _____ Pieces _____
Date left _____
Date to pick-up _____
001
BAGGAGE CLAIM CHECK
Name _____
Room _____ Pieces _____
Date left _____
Date to pick-up _____
001
Important: Read conditions on reverse side.

Front

English

Back

18953	
This check is issued subject to the following conditions and in accepting, the holder thereof agrees to each and all such conditions. 1. That the property for which it was issued may be delivered to any person presenting this check and will not be delivered except upon presentation and surrender of this check. 2. That the owner or owners of the property checked hereunder assumes all risk of damage by fire, water, theft or from other causes. 3. Liability for loss, damage, or theft of the baggage shall be limited to the amount set by law unless a separate agreement between the bailor and bailee has established a different amount. 4. Baggage left an unreasonable length of time will be disposed of in accordance with state law.	

P18954

18954
Nombre _____
Habitación _____ Número de piezas _____
Fecha de recepción _____
Fecha de entrega _____
001
RECIBO PARA RECLAMO DE EQUIPAJE BAGGAGE CLAIM CHECK
Nombre _____
Habitación _____ Número de piezas _____
Fecha de recepción _____
Fecha de entrega _____
001
Importante: Lea las condiciones al reverso.

Front

Spanish

Back

18954	
Una vez que este recibo sea complementado y aceptado, el portador del mismo quedará sujeto a las siguientes condiciones: 1. El equipaje correspondiente podrá ser entregado a cualquier persona portadora de este recibo, y sólo será entregado bajo presentación y entrega del mismo. 2. El dueño o dueños del equipaje asume(n) todos los riesgos de aquellos daños causados por incendio, agua, robo u otras causas. 3. La responsabilidad por pérdida, daño o robo del equipaje estará limitada a la cantidad impuesta por la ley, a menos que exista un acuerdo adicional entre el fiador y el depositario que establezca una cantidad diferente. 4. El equipaje abandonado por un tiempo excesivo será destruido de acuerdo a lo que dispone la ley.	

HOSPITALITY COAT CHECK TAGS

Coat Check Tags

90# Index stock colors as indicated, printed black, red numbering sequence is 000 to 999

	Description	Dimensions	Box	Ctn	Price
P18920	Blue Stock	6¾" x 2½"	1000	10BX	
P18921	Pink Stock	6¾" x 2½"	1000	10BX	
P18922	Yellow Stock	6¾" x 2½"	1000	10BX	
P18923	Green Stock	6¾" x 2½"	1000	10BX	
P18924	Orange Stock	6¾" x 2½"	1000	10BX	

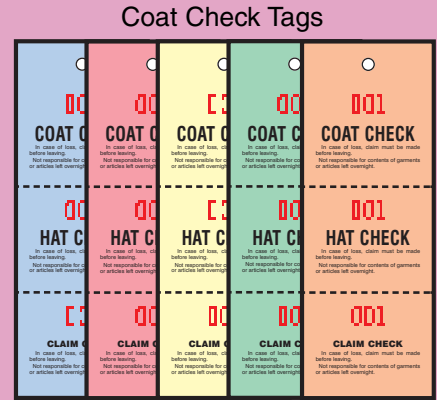

Coat Room Check Tags

10 pt. CSU stock colors as indicated, printed black, black numbering sequence is 000 to 999

	Description	Dimensions	Box	Ctn	Price
P18930	White Stock	1½" x 6¾"	1000	10BX	
P18931	Blue Stock	1½" x 6¾"	1000	10BX	
P18932	Red Stock	1½" x 6¾"	1000	10BX	
P18933	Orange Stock	1½" x 6¾"	1000	10BX	

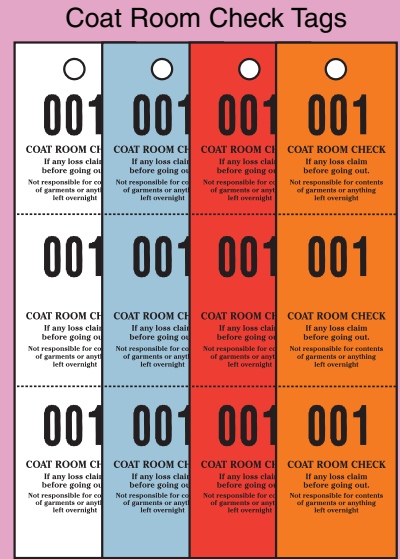

Coat Check Tags

10 pt. uncoated white, printed black. Hole punched (3/8") to fit over a hanger. Duplicate and triplicate designs available.

	Description	Dimensions	Box	Ctn	Price
P18900	000 - 499 - Duplicate	3¼" x 1¼"	500	20BX	
P18901	500 - 999 - Duplicate	3¼" x 1¼"	500	20BX	
P18910	000 - 499 - Triplicate	4" x 1¼"	500	20BX	
P18911	500 - 999 - Triplicate	4" x 1¼"	500	20BX	

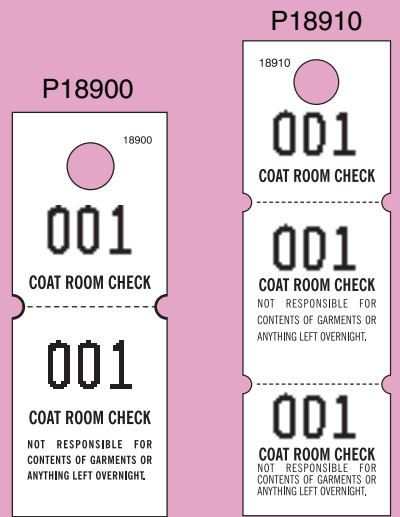

Duplicate Tags - Looped String

Manila stock, printed black. Duplicate numbers in black, "Retain This Check" in red. Fiber patched and looped string.

	Description	Dimensions	Box	Ctn	Price
P18670	000 - 499	4¾" x 2¾"	500	10BX	
P18671	500 - 999	4¾" x 2¾"	500	10BX	

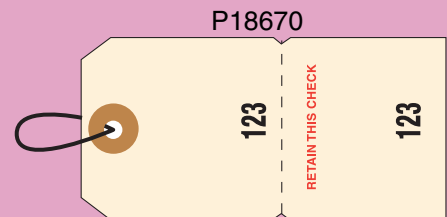

HOSPITALITY - SPECIALIZED

Property Tag - Knotted String

	Description	Size	Dimensions	Box	Ctn	Price
P18960	Lost & Found Tag	Manila uncoated stock, printed black	7	5¾" x 2½"	100	20BX

Door Hang Tag

	Description	Dimensions	Box	Ctn	Price
P17600	Blank Bulk Mailer	White stock with self sealing strip, die cut for hanging, postal approved	12⅝" x 4"	500	
P60350	Door Hanger	White Hi-strength Polyart, printed red and green, diecut for hanging	4¼" x 11"	500	50BX

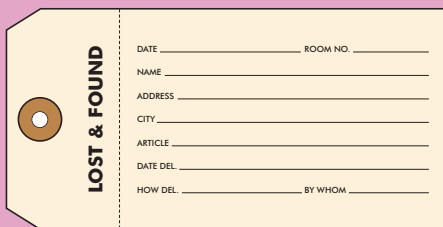

P18960

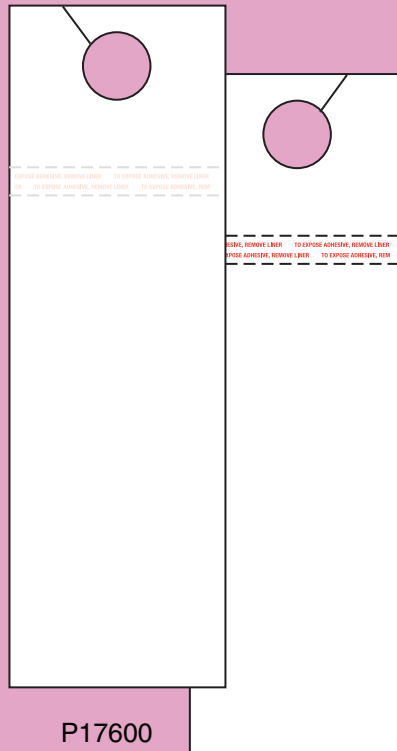

P17600

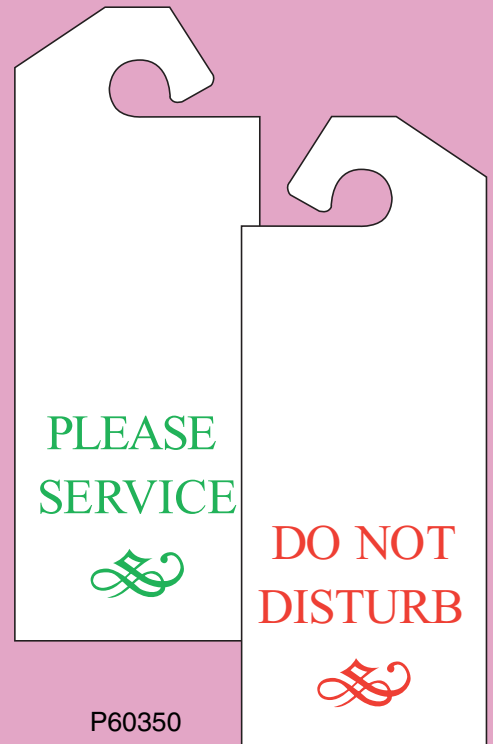

P60350

ATTACHMENTS

Loose Strings

	Description	Size	Bundle	Ctn
P18109	#9 Unpolished Cotton String	12"	1000	

Loose Elastic

	Description	Size	Box	Ctn
P18111	Knotted White Elastic 3" Hole to Knot	3"	1000	

Loose Wires

	Description	Size	Bundle	Ctn
P18412	Heavy 21 Gauge Wire	12"	1000	20
P18432	Medium 23 Gauge Wire	12"	1000	25
P18462	Light 26 Gauge Wire	12"	1000	25
P18462-500	Light 26 Gauge Wire	12"	500	50
P18467	Light 26 Gauge Wire	7 1/2"	1000	25

Copper Parcel Hooks

	Description	Size	Box	Ctn
P18505	Copper Coated Steel Wire	2"x 5/8"	1000	25

Tin Coated Steel Wire

	Description	Size	Box	Ctn
P18550	#7 Tin Coated Steel Wire	1 1/8"x 5/16"	1000	25

17 Gauge Deadlocks

	Description	Box	Ctn
P18541	Diamond, sharp point	1000	25
P18542	Diamond, blunt point	1000	25
P18543	Diamond, semi-blunt point	1000	25
P18547	Oval, sharp point	1000	25
P18548	Oval, blunt point	1000	25

TACH-IT® Identification System

	Description	Box	Ctn
P08350	5" Securities	5000	10
P09100	Mini TACH-IT® 2 Gun	1	
P09110	Standard Mini TACH-IT® 2-Needles	3	
P09111	Heavy Duty Mini TACH-IT® 2-Needles	3	
P09121	1" TACH-IT® Barbs	5000	10
P09122	3" TACH-IT® Barbs	5000	10
P09130	5" Security Loops	5000	10
P09131	9" Security Loops	5000	10

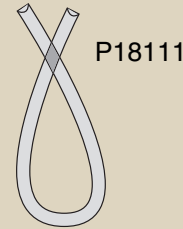
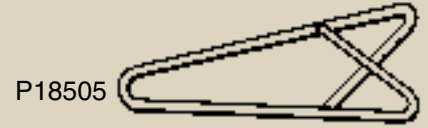
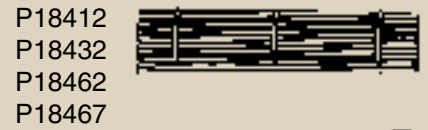

P18111



P18550



P18541

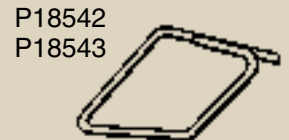

P18542
P18543

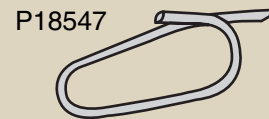

P18547

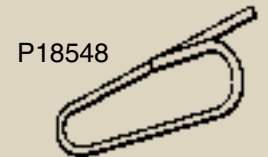

P18548

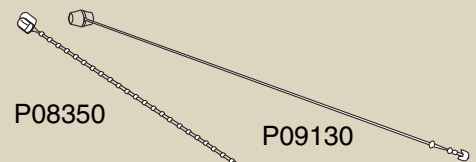

P08350

P09130

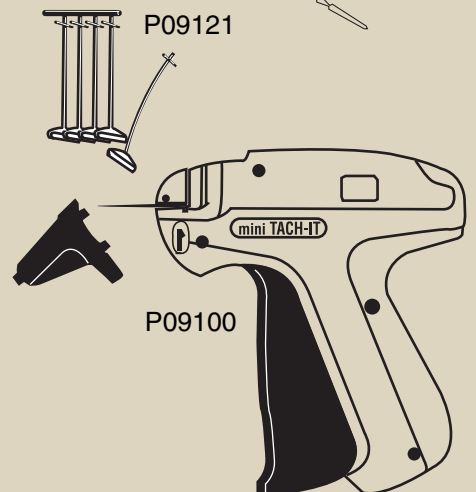

P09121

P09100

INDEX

Item No.	Page	Description	Item No.	Page	Description
P08350	33	5" Securities	P11348	4	(8) 13 CSU Red Tag
P09100	33	Mini TACH-IT 2" Gun	P11348W	4	(8) 13 CSU Red Tag, Wired
P09110	33	TACH-IT Needles, Standard	P11351	4	(1) 13 CSU Dk. Blue Tag
P09111	33	TACH-IT Needles, Heavy Duty	P11351L	4	(1) 13 CSU Lt. Blue Tag
P09121	33	1" TACH-IT Barbs (08960)	P11352	4	(2) 13 CSU Dk. Blue Tag
P09122	33	3" TACH-IT Barbs (08952)	P11352L	4	(2) 13 CSU Lt. Blue Tag
P09130	33	5" Security Loops (08311)	P11353	4	(3) 13 CSU Dk. Blue Tag
P09131	33	9" Security Loops (08312)	P11353L	4	(3) 13 CSU Lt. Blue Tag
P11181	8	(1) #5 Cloth Tag w/Eyelet	P11354	4	(4) 13 CSU Dk. Blue Tag
P11185	8	(5) #5 Cloth Tag w/Eyelet	P11354L	4	(4) 13 CSU Lt. Blue Tag
P11240	5	15 SU Manila Tag	P11355	4	(5) 13 CSU Dk. Blue Tag
P11250	5	15 SU Manila Tag	P11355L	4	(5) 13 CSU Lt. Blue Tag
P11251	5	15 SU White Tag	P11355LW	4	(5) 13 CSU Lt. Blue Tag, Wired
P11252	5	15 SU Yellow Tag	P11355W	4	(5) 13 CSU Dk. Blue Tag, Wired
P11253	5	15 SU Red Tag	P11356	4	(6) 13 CSU Dk. Blue Tag
P11254	5	15 SU Lt. Blue Tag	P11356L	4	(6) 13 CSU Lt. Blue Tag
P11255	5	15 SU Dk. Blue Tag	P11357	4	(7) 13 CSU Dk. Blue Tag
P11256	5	15 SU Lt. Green Tag	P11357L	4	(7) 13 CSU Lt. Blue Tag
P11257	5	15 SU Orange Tag	P11358	4	(8) 13 CSU Dk. Blue Tag
P11258	5	15 SU Pink Tag	P11358L	4	(8) 13 CSU Lt. Blue Tag
P11259	5	15 SU Gray	P11358LW	4	(8) 13 CSU Lt. Blue Tag, Wired
P11301	6	(1) 13 SU Manila Tag	P11358W	4	(8) 13 CSU Dk. Blue Tag, Wired
P11302	6	(2) 13 SU Manila Tag	P11361	4	(1) 13 CSU Lt. Green Tag
P11303	6	(3) 13 SU Manila Tag	P11361D	4	(1) 13 CSU Dk. Green Tag
P11304	6	(4) 13 SU Manila Tag	P11362	4	(2) 13 CSU Lt. Green Tag
P11305	6	(5) 13 SU Manila Tag	P11362D	4	(2) 13 CSU Dk. Green Tag
P11306	6	(6) 13 SU Manila Tag	P11363	4	(3) 13 CSU Lt. Green Tag
P11307	6	(7) 13 SU Manila Tag	P11363D	4	(3) 13 CSU Dk. Green Tag
P11308	6	(8) 13 SU Manila Tag	P11364	4	(4) 13 CSU Lt. Green Tag
P11311	4	(1) 13 CSU White Tag	P11364D	4	(4) 13 CSU Dk. Green Tag
P11312	4	(2) 13 CSU White Tag	P11365	4	(5) 13 CSU Lt. Green Tag
P11313	4	(3) 13 CSU White Tag	P11365D	4	(5) 13 CSU Dk. Green Tag
P11314	4	(4) 13 CSU White Tag	P11365W	4	(5) 13 CSU Lt. Green Tag, Wired
P11315	4	(5) 13 CSU White Tag	P11365DW	4	(5) 13 CSU Dk. Green Tag, Wired
P11315W	4	(5) 13 CSU White Tag, Wired	P11366	4	(6) 13 CSU Lt. Green Tag
P11316	4	(6) 13 CSU White Tag	P11366D	4	(6) 13 CSU Dk. Green Tag
P11317	4	(7) 13 CSU White Tag	P11367	4	(7) 13 CSU Lt. Green Tag
P11318	4	(8) 13 CSU White Tag	P11367D	4	(7) 13 CSU Dk. Green Tag
P11318W	4	(8) 13 CSU White Tag, Wired	P11368	4	(8) 13 CSU Lt. Green Tag
P11321	4	(1) 13 CSU Yellow Tag	P11368D	4	(8) 13 CSU Dk. Green Tag
P11322	4	(2) 13 CSU Yellow Tag	P11368W	4	(8) 13 CSU Lt. Green Tag, Wired
P11323	4	(3) 13 CSU Yellow Tag	P11368DW	4	(8) 13 CSU Dk. Green Tag, Wired
P11324	4	(4) 13 CSU Yellow Tag	P11371	4	(1) 13 CSU Orange Tag
P11325	4	(5) 13 CSU Yellow Tag	P11372	4	(2) 13 CSU Orange Tag
P11325W	4	(5) 13 CSU Yellow Tag, Wired	P11373	4	(3) 13 CSU Orange Tag
P11326	4	(6) 13 CSU Yellow Tag	P11374	4	(4) 13 CSU Orange Tag
P11327	4	(7) 13 CSU Yellow Tag	P11375	4	(5) 13 CSU Orange Tag
P11328	4	(8) 13 CSU Yellow Tag	P11375W	4	(5) 13 CSU Orange Tag, Wired
P11328W	4	(8) 13 CSU Yellow Tag, Wired	P11376	4	(6) 13 CSU Orange Tag
P11331	4	(1) 13 CSU Lilac Tag	P11377	4	(7) 13 CSU Orange Tag
P11332	4	(2) 13 CSU Lilac Tag	P11378	4	(8) 13 CSU Orange Tag
P11333	4	(3) 13 CSU Lilac Tag	P11378W	4	(8) 13 CSU Orange Tag, Wired
P11334	4	(4) 13 CSU Lilac Tag	P11381	4	(1) 13 CSU Pink Tag
P11335	4	(5) 13 CSU Lilac Tag	P11382	4	(2) 13 CSU Pink Tag
P11335W	4	(5) 13 CSU Lilac Tag, Wired	P11383	4	(3) 13 CSU Pink Tag
P11336	4	(6) 13 CSU Lilac Tag	P11384	4	(4) 13 CSU Pink Tag
P11337	4	(7) 13 CSU Lilac Tag	P11385	4	(5) 13 CSU Pink Tag
P11338	4	(8) 13 CSU Lilac Tag	P11385W	4	(5) 13 CSU Pink Tag, Wired
P11338W	4	(8) 13 CSU Lilac Tag, Wired	P11386	4	(6) 13 CSU Pink Tag
P11341	4	(1) 13 CSU Red Tag	P11387	4	(7) 13 CSU Pink Tag
P11342	4	(2) 13 CSU Red Tag	P11388	4	(8) 13 CSU Pink Tag
P11343	4	(3) 13 CSU Red Tag	P11388W	4	(8) 13 CSU Pink Tag, Wired
P11344	4	(4) 13 CSU Red Tag	P11391	4	(1) 13 CSU Grey Tag
P11345	4	(5) 13 CSU Red Tag	P11392	4	(2) 13 CSU Grey Tag
P11345W	4	(5) 13 CSU Red Tag, Wired	P11393	4	(3) 13 CSU Grey Tag
P11346	4	(6) 13 CSU Red Tag	P11394	4	(4) 13 CSU Grey Tag
P11347	4	(7) 13 CSU Red Tag	P11395	4	(5) 13 CSU Grey Tag
			P11395W	4	(5) 13 CSU Grey Tag, Wired
			P11396	4	(6) 13 CSU Grey Tag
			P11397	4	(7) 13 CSU Grey Tag

INDEX

Item No.	Page	Description	Item No.	Page	Description
P11398	4	(8) 13 CSU Grey Tag	P11692	6	(2) 10 SU Manila Tag, Wired
P11398W	4	(8) 13 CSU Grey Tag, Wired	P11693	6	(3) 10 SU Manila Tag, Wired
P11415	7	(5) Tyvek® Red Tag	P11694	6	(4) 10 SU Manila Tag, Wired
P11415W	7	(5) Tyvek® Red Tag, Wired	P11695	6	(5) 10 SU Manila Tag, Wired
P11425	7	(5) Tyvek® Yellow Tag	P11696	6	(6) 10 SU Manila Tag, Wired
P11425W	7	(5) Tyvek® Yellow Tag, Wired	P11697	6	(7) 10 SU Manila Tag, Wired
P11435	7	(5) Tyvek® Green Tag	P11698	6	(8) 10 SU Manila Tag, Wired
P11435W	7	(5) Tyvek® Green Tag, Wired	P11701	5	(1) 13 Fluorescent Red Tag
P11418	7	(8) Tyvek® Red Tag	P11702	5	(2) 13 Fluorescent Red Tag
P11418W	7	(8) Tyvek® Red Tag, Wired	P11703	5	(3) 13 Fluorescent Red Tag
P11428	7	(8) Tyvek® Yellow Tag	P11704	5	(4) 13 Fluorescent Red Tag
P11428W	7	(8) Tyvek® Yellow Tag, Wired	P11705	5	(5) 13 Fluorescent Red Tag
P11438	7	(8) Tyvek® Green Tag	P11705W	5	(5) 13 Fluorescent Red Tag, Wired
P11438W	7	(8) Tyvek® Green Tag, Wired	P11706	5	(6) 13 Fluorescent Red Tag
P11441	7	(1) Tyvek® White Tag	P11706W	5	(6) 13 Fluorescent Red Tag, Wired
P11441W	7	(1) Tyvek® White Tag, Wired	P11707	5	(7) 13 Fluorescent Red Tag
P11442	7	(2) Tyvek® White Tag	P11708	5	(8) 13 Fluorescent Red Tag
P11442W	7	(2) Tyvek® White Tag, Wired	P11708W	5	(8) 13 Fluorescent Red Tag, Wired
P11443	7	(3) Tyvek® White Tag	P11711	5	(1) 13 Fluorescent Yellow Tag
P11443W	7	(3) Tyvek® White Tag, Wired	P11712	5	(2) 13 Fluorescent Yellow Tag
P11444	7	(4) Tyvek® White Tag	P11713	5	(3) 13 Fluorescent Yellow Tag
P11444W	7	(4) Tyvek® White Tag, Wired	P11714	5	(4) 13 Fluorescent Yellow Tag
P11445	7	(5) Tyvek® White Tag	P11715	5	(5) 13 Fluorescent Yellow Tag
P11445W	7	(5) Tyvek® White Tag, Wired	P11715W	5	(5) 13 Fluorescent Yellow Tag, Wired
P11446	7	(6) Tyvek® White Tag	P11716	5	(6) 13 Fluorescent Yellow Tag
P11446W	7	(6) Tyvek® White Tag, Wired	P11716W	5	(6) 13 Fluorescent Yellow Tag, Wired
P11447	7	(7) Tyvek® White Tag	P11717	5	(7) 13 Fluorescent Yellow Tag
P11447W	7	(7) Tyvek® White Tag, Wired	P11718	5	(8) 13 Fluorescent Yellow Tag
P11448	7	(8) Tyvek® White Tag	P11718W	5	(8) 13 Fluorescent Yellow Tag, Wired
P11448W	7	(8) Tyvek® White Tag, Wired	P11721	5	(1) 13 Fluorescent Green Tag
P11455	7	(5) Blue floodcoated Tyvek® Tag	P11722	5	(2) 13 Fluorescent Green Tag
P11455W	7	(5) Blue floodcoated Tyvek® Tag, Wired	P11723	5	(3) 13 Fluorescent Green Tag
P11458	7	(8) Blue floodcoated Tyvek® Tag	P11724	5	(4) 13 Fluorescent Green Tag
P11458W	7	(8) Blue floodcoated Tyvek® Tag, Wired	P11725	5	(5) 13 Fluorescent Green Tag
P11491	6	(1) 10 SU Manila Tag	P11725W	5	(5) 13 Fluorescent Green Tag, Wired
P11492	6	(2) 10 SU Manila Tag	P11726	5	(6) 13 Fluorescent Green Tag
P11493	6	(3) 10 SU Manila Tag	P11726W	5	(6) 13 Fluorescent Green Tag, Wired
P11494	6	(4) 10 SU Manila Tag	P11727	5	(7) 13 Fluorescent Green Tag
P11495	6	(5) 10 SU Manila Tag	P11728	5	(8) 13 Fluorescent Green Tag
P11496	6	(6) 10 SU Manila Tag	P11728W	5	(8) 13 Fluorescent Green Tag, Wired
P11497	6	(7) 10 SU Manila Tag	P11731	5	(1) 13 Fluorescent Pink Tag
P11498	6	(8) 10 SU Manila Tag	P11732	5	(2) 13 Fluorescent Pink Tag
P11501	6	(1) 13 SU Manila Tag, Strung	P11733	5	(3) 13 Fluorescent Pink Tag
P11502	6	(2) 13 SU Manila Tag, Strung	P11734	5	(4) 13 Fluorescent Pink Tag
P11503	6	(3) 13 SU Manila Tag, Strung	P11735	5	(5) 13 Fluorescent Pink Tag
P11504	6	(4) 13 SU Manila Tag, Strung	P11735W	5	(5) 13 Fluorescent Pink Tag, Wired
P11505	6	(5) 13 SU Manila Tag, Strung	P11736	5	(6) 13 Fluorescent Pink Tag
P11506	6	(6) 13 SU Manila Tag, Strung	P11736W	5	(6) 13 Fluorescent Pink Tag, Wired
P11507	6	(7) 13 SU Manila Tag, Strung	P11737	5	(7) 13 Fluorescent Pink Tag
P11508	6	(8) 13 SU Manila Tag, Strung	P11738	5	(8) 13 Fluorescent Pink Tag
P11591	6	(1) 10 SU Manila Tag, Strung	P11738W	5	(8) 13 Fluorescent Pink Tag, Wired
P11592	6	(2) 10 SU Manila Tag, Strung	P11741	5	(1) 13 Fluorescent Orange Tag
P11593	6	(3) 10 SU Manila Tag, Strung	P11742	5	(2) 13 Fluorescent Orange Tag
P11594	6	(4) 10 SU Manila Tag, Strung	P11743	5	(3) 13 Fluorescent Orange Tag
P11595	6	(5) 10 SU Manila	P11744	5	(4) 13 Fluorescent Orange Tag
P11596	6	(6) 10 SU Manila Tag, Strung	P11745	5	(5) 13 Fluorescent Orange Tag
P11597	6	(7) 10 SU Manila Tag, Strung	P11745W	5	(5) 13 Fluorescent Orange Tag, Wired
P11598	6	(8) 10 SU Manila Tag, Strunged	P11746	5	(6) 13 Fluorescent Orange Tag, Strung
P11601	6	(1) 13 SU Manila Tag, Wired	P11746W	5	(6) 13 Fluorescent Orange Tag, Wired
P11602	6	(2) 13 SU Manila Tag, Wired	P11747	5	(7) 13 Fluorescent Orange Tag
P11603	6	(3) 13 SU Manila Tag, Wired	P11748	5	(8) 13 Fluorescent Orange Tag
P11604	6	(4) 13 SU Manila Tag, Wired	P11748W	5	(8) 13 Fluorescent Orange Tag, Wired
P11605	6	(5) 13 SU Manila Tag, Wired	P11804	6	(4) 13 SU Manila, 4 Gang Tag
P11606	6	(6) 13 SU Manila Tag, Wired	P11805	6	(5) 13 SU Manila, 4 Gang Tag
P11607	6	(7) 13 SU Manila Tag, Wired	P11806	6	(6) 13 SU Manila, 4 Gang Tag
P11608	6	(8) 13 SU Manila Tag, Wired	P11808	6	(8) 13 SU Manila, 4 Gang Tag
P11691	6	(1) 10 SU Manila Tag, Wired	P11911	4	(1) 13 CSU Brown Tag
			P11912	4	(2) 13 CSU Brown Tag

INDEX

Item No.	Page	Description	Item No.	Page	Description
P11913	4	(3) 13 CSU Brown Tag	P14368	7	(8) Vinyl Tags, Red
P11914	4	(4) 13 CSU Brown Tag	P14375	7	(5) Vinyl Tags, Blue
P11915	4	(5) 13 CSU Brown Tag	P14378	7	(8) Vinyl Tags, Blue
P11915W	4	(5) 13 CSU Brown Tag, Wired	P14385	7	(5) Vinyl Tags, Green
P11916	4	(6) 13 CSU Brown Tag	P14388	7	(8) Vinyl Tags, Green
P11917	4	(7) 13 CSU Brown Tag	P14395	7	(5) Vinyl Tags, Orange
P11918	4	(8) 13 CSU Brown Tag	P14398	7	(8) Vinyl Tags, Orange
P11918W	4	(8) 13 CSU Brown Tag, Wired			
P11931	4	(1) 13 CSU Ivory Tag	P14323	7	3" Yellow Circle Vinyl Tag
P11932	4	(2) 13 CSU Ivory Tag	P14343	7	3" Red Circle Vinyl Tag
P11933	4	(3) 13 CSU Ivory Tag	P14353	7	3" Blue Circle Vinyl Tag
P11934	4	(4) 13 CSU Ivory Tag	P14363	7	3" Green Circle Vinyl Tag
P11935	4	(5) 13 CSU Ivory Tag	P14373	7	3" White Circle Vinyl Tag
P11935W	4	(5) 13 CSU Ivory Tag, Wired	P14527	14	(7) 3 Color Process Control Tag
P11936	4	(6) 13 CSU Ivory Tag	P15010	18	(7) Alteration Tag (000-499)
P11937	4	(7) 13 CSU Ivory Tag			
P11938	4	(8) 13 CSU Ivory Tag	P15016	13	(5) Yellow Inspection Tag
P11938W	4	(8) 13 CSU Ivory Tag, Wired	P15017	13	(5) Rejected Tag Red
P11951	4	(1) 13 CSU Salmon Tag	P15018	13	(5) Repair/Rework Tag Green
P11952	4	(2) 13 CSU Salmon Tag	P15019	13	(5) Accepted Tag, Blue
P11953	4	(3) 13 CSU Salmon Tag	P15020	13	(5) Scrap Tag Yellow
P11954	4	(4) 13 CSU Salmon Tag	P15021	13	(5) Accepted Tag, Green
P11955	4	(5) 13 CSU Salmon Tag			
P11955W	4	(5) 13 CSU Salmon Tag, Wired	P15022	13	(5) 2-Part Rejected Tag (000-499)
P11956	4	(6) 13 CSU Salmon Tag	P15023	13	(5) 2-Part Rejected Tag (500-999)
P11957	4	(7) 13 CSU Salmon Tag	P15024	13	(5) 2-Part Repair/Rework Tag (000-499)
P11958	4	(8) 13 CSU Salmon Tag	P15026	13	(5) 2-Part Accepted Tag (000-499)
P11958W	4	(8) 13 CSU Salmon Tag, Wired	P15027	13	(5) 2-Part Accepted Tag (500-999)
			P15028	13	(5) 2-Part Scrap Tag (000-499)
			P15029	13	(5) 2-Part Scrap Tag (500-999)
P12108	16	White Merchandise Tag 1 $\frac{3}{4}$ " Dia.	P15030	18	(6) Repair Tag (000-999)
P12109	16	White Merchandise Tag 1 $\frac{3}{4}$ " Dia.	P15032	18	(6) Repair Tag (1000-1999)
P12200	16	White Merchandise Tag 2" x 3 $\frac{1}{4}$ "			
P12201	16	White Merchandise Tag 1 $\frac{3}{4}$ " x 2 $\frac{1}{8}$ "	P15033	14	(5) Yellow Scrap/Remarks Tag
P12202	16	White Merchandise Tag 1 $\frac{1}{8}$ " x 2 $\frac{3}{16}$ "	P15034	14	(5) Yellow Return to Stock Tag
P12203	16	White Merchandise Tag 1 $\frac{1}{4}$ " x 1 $\frac{1}{8}$ "	P15035	14	(5) Dk Green Tested Tag
P12204	16	White Merchandise Tag 1 $\frac{1}{8}$ " x 1 $\frac{1}{4}$ "	P15036	14	(5) Dk Green Inspected Tag
P12205	16	White Merchandise Tag 1 $\frac{5}{16}$ " x 1 $\frac{1}{2}$ "	P15038	14	(5) White Sample Tag
P12206	16	White Merchandise Tag 1 $\frac{1}{8}$ " x 1 $\frac{1}{4}$ "			
P12207	16	White Merchandise Tag 3 $\frac{1}{4}$ " x 1 $\frac{1}{8}$ "	P15040	18	Layaway Tag 7" x 3 $\frac{1}{8}$ " (000-499)
P12211	16	White Merchandise Tag 5 $\frac{1}{8}$ " x 1 $\frac{5}{16}$ "			
P12421	16	Yellow Merchandise Tag 1 $\frac{3}{4}$ " x 2 $\frac{1}{8}$ "	P15045	15	(8) Part Tag (0000-0999)
P12425	16	Yellow Merchandise Tag 1 $\frac{5}{16}$ " x 1 $\frac{1}{2}$ "	P15046	15	(8) Move Ticket (0000-0999)
			P15047	15	(8) Non-conforming Tag (0000-0999)
P12441	16	Red Merchandise Tag 1 $\frac{3}{4}$ " x 2 $\frac{1}{4}$ "	P15050	15	(8) Danger Tag
P12445	16	Red Merchandise Tag 1 $\frac{5}{16}$ " x 1 $\frac{1}{2}$ "			
P12451	16	Green Merchandise Tag 1 $\frac{3}{4}$ " x 2 $\frac{1}{8}$ "	P15083	19	Blue Furniture Price Tag
P12455	16	Green Merchandise Tag 1 $\frac{5}{16}$ " x 1 $\frac{1}{2}$ "	P15084	19	Ivory Furniture Price Tag
			P15086	19	Utility Price Tag
P13045	16	White Jewelry Tag, Red String 7 $\frac{1}{16}$ " x 3 $\frac{1}{4}$ "	P15088	20	Large Sale Tag
P13055	16	White Jewelry Tag, Red String 1 $\frac{1}{4}$ " x 1 $\frac{1}{16}$ "			
P13085	16	White Jewelry Tag, Red String 7 $\frac{1}{16}$ " x 1 $\frac{1}{4}$ "	P15100	10	(8) Inventory (2 Pt) (000-499)
P13095	16	White Jewelry Tag, Red String 7 $\frac{1}{16}$ " x 1 $\frac{5}{16}$ "	P15101	10	(8) Inventory (2 Pt) (500-999)
P13165	16	White Jewelry Tag, Green String 5 $\frac{1}{16}$ " x 1 $\frac{1}{16}$ "	P15102	10	(8) Inventory (2 Pt) (1000-1499)
			P15103	10	(8) Inventory (2 Pt) (1500-1999)
P13206	16	Kromekote Ring Tags 5 $\frac{1}{16}$ " x 1 $\frac{1}{2}$ "	P15104	10	(8) Inventory (2 Pt) (2000-2499)
P13226	16	Kromekote Ring Tags 7 $\frac{1}{16}$ " x 1 $\frac{1}{8}$ "	P15105	10	(8) Inventory (2 Pt) (2500-2999)
P13406	16	Tyvek® Ring Tags 5 $\frac{1}{16}$ " x 1 $\frac{1}{2}$ "	P15106	10	(8) Inventory (2 Pt) (3000-3499)
P13426	16	Tyvek® Ring Tags 7 $\frac{1}{16}$ " x 1 $\frac{1}{8}$ "	P15107	10	(8) Inventory (2 Pt) (3500-3999)
			P15108	10	(8) Inventory (2 Pt) (4000-4499)
P14305	7	(5) Vinyl Tags, White	P15109	10	(8) Inventory (2 Pt) (4500-4999)
P14308	7	(8) Vinyl Tags, White	P15110	10	(8) Inventory (2 Pt) (5000-5499)
			P15111	10	(8) Inventory (2 Pt) (5500-5999)
P14312	14	White Metal Rim Tag 1 $\frac{5}{16}$ " Diameter	P15112	10	(8) Inventory (2 Pt) (6000-6499)
P14313	14	White Metal Rim Tag 1 $\frac{1}{4}$ " Diameter	P15113	10	(8) Inventory (2 Pt) (6500-6999)
P14314	14	White Metal Rim Tag 1 $\frac{3}{16}$ " Diameter	P15114	10	(8) Inventory (2 Pt) (7000-7499)
P14315	14	White Metal Rim Tag 1 $\frac{1}{8}$ " Diameter	P15115	10	(8) Inventory (2 Pt) (7500-7999)
			P15116	10	(8) Inventory (2 Pt) (8000-8499)
P14325	7	(5) Vinyl Tags, Yellow	P15117	10	(8) Inventory (2 Pt) (8500-8999)
P14328	7	(8) Vinyl Tags, Yellow	P15118	10	(8) Inventory (2 Pt) (9000-9499)
P14365	7	(5) Vinyl Tags, Red	P15119	10	(8) Inventory (2 Pt) (9500-9999)

INDEX

Item No.	Page	Description	Item No.	Page	Description
P15161	24	(5) Sold Tag, Red & Black	P15391	11	(8) Inventory (2 Pt) (15,500-15,999)
P15165	24	(5) Sold Tag, Red & White	P15392	11	(8) Inventory (2 Pt) (16,000-16,499)
P15166	24	(5) Hold Tag, Blue & White	P15393	11	(8) Inventory (2 Pt) (16,500-16,999)
P15208	21	Sale Price Tag	P15394	11	(8) Inventory (2 Pt) (17,000-17,499)
P15220	21	(8) Special Sale Tag	P15395	11	(8) Inventory (2 Pt) (17,500-17,999)
P15223	21	(6) Special Sale Tag	P15396	11	(8) Inventory (2 Pt) (18,000-18,499)
P15251	21	Special Sale Tag	P15397	11	(8) Inventory (2 Pt) (18,500-18,999)
P15300	11	(8) Inventory (2 Pt) (0000-0499)	P15398	11	(8) Inventory (2 Pt) (19,000-19,499)
P15301	11	(8) Inventory (2 Pt) (0500-0999)	P15399	11	(8) Inventory (2 Pt) (19,500-19,999)
P15302	11	(8) Inventory (2 Pt) (1000-1499)	P15400	9	(8) Inventory Manila (0000-0999)
P15303	11	(8) Inventory (2 Pt) (1500-1999)	P15401	9	(8) Inventory Manila (1000-1999)
P15304	11	(8) Inventory (2 Pt) (2000-2499)	P15402	9	(8) Inventory Manila (2000-2999)
P15305	11	(8) Inventory (2 Pt) (2500-2999)	P15403	9	(8) Inventory Manila (3000-3999)
P15306	11	(8) Inventory (2 Pt) (3000-3499)	P15404	9	(8) Inventory Manila (4000-4999)
P15307	11	(8) Inventory (2 Pt) (3500-3999)	P15405	9	(8) Inventory Manila (5000-5999)
P15308	11	(8) Inventory (2 Pt) (4000-4499)	P15406	9	(8) Inventory Manila (6000-6999)
P15309	11	(8) Inventory (2 Pt) (4500-4999)	P15407	9	(8) Inventory Manila (7000-7999)
P15310	11	(8) Inventory (2 Pt) (5000-5499)	P15408	9	(8) Inventory Manila (8000-8999)
P15311	11	(8) Inventory (2 Pt) (5500-5999)	P15409	9	(8) Inventory Manila (9000-9999)
P15312	11	(8) Inventory (2 Pt) (6000-6499)	P15410	9	(8) Inventory Manila (10,000-10,999)
P15313	11	(8) Inventory (2 Pt) (6500-6999)	P15411	9	(8) Inventory Manila (11,000-11,999)
P15314	11	(8) Inventory (2 Pt) (7000-7499)	P15412	9	(8) Inventory Manila (12,000-12,999)
P15315	11	(8) Inventory (2 Pt) (7500-7999)	P15413	9	(8) Inventory Manila (13,000-13,999)
P15316	11	(8) Inventory (2 Pt) (8000-8499)	P15414	9	(8) Inventory Manila (14,000-14,999)
P15317	11	(8) Inventory (2 Pt) (8500-8999)	P15415	9	(8) Inventory Manila (15,000-15,999)
P15318	11	(8) Inventory (2 Pt) (9000-9499)	P15416	9	(8) Inventory Manila (16,000-16,999)
P15319	11	(8) Inventory (2 Pt) (9500-9999)	P15417	9	(8) Inventory Manila (17,000-17,999)
P15320	10	(8) Inventory (3 Pt) (0000-0499)	P15418	9	(8) Inventory Manila (18,000-18,999)
P15320	10	(8) Inventory (3 Pt) (000-499)	P15419	9	(8) Inventory Manila (19,000-19,999)
P15321	10	(8) Inventory (3 Pt) (500-999)	P15420	9	(8) Blank (3 Pt) (0000-0499)
P15322	10	(8) Inventory (3 Pt) (1000-1499)	P15421	9	(8) Blank (3 Pt) (0500-0999)
P15323	10	(8) Inventory (3 Pt) (1500-1999)	P15422	9	(8) Blank (3 Pt) (1000-1499)
P15324	10	(8) Inventory (3 Pt) (2000-2499)	P15423	9	(8) Blank (3 Pt) (1500-1999)
P15325	10	(8) Inventory (3 Pt) (2500-2999)	P15424	9	(8) Blank (3 Pt) (2000-2499)
P15326	10	(8) Inventory (3 Pt) (3000-3499)	P15425	9	(8) Blank (3 Pt) (2500-2999)
P15327	10	(8) Inventory (3 Pt) (3500-3999)	P15426	9	(8) Blank (3 Pt) (3000-3499)
P15328	10	(8) Inventory (3 Pt) (4000-4499)	P15427	9	(8) Blank (3 Pt) (3500-3999)
P15329	10	(8) Inventory (3 Pt) (4500-4999)	P15428	9	(8) Blank (3 Pt) (4000-4499)
P15330	10	(8) Inventory (3 Pt) (5000-5499)	P15429	9	(8) Blank (3 Pt) (4500-4999)
P15331	10	(8) Inventory (3 Pt) (5500-5999)	P15500	12	(8) Inventory (2 Pt) T-Tape (0000-0499)
P15333	10	(8) Inventory (3 Pt) (6500-6999)	P15501	12	(8) Inventory (2 Pt) T-Tape (0500-0999)
P15334	10	(8) Inventory (3 Pt) (7000-7499)	P15502	12	(8) Inventory (2 Pt) T-Tape (1000-1499)
P15335	10	(8) Inventory (3 Pt) (7500-7999)	P15503	12	(8) Inventory (2 Pt) T-Tape (1500-1999)
P15336	10	(8) Inventory (3 Pt) (8000-8499)	P15504	12	(8) Inventory (2 Pt) T-Tape (2000-2499)
P15337	10	(8) Inventory (3 Pt) (8500-8999)	P15505	12	(8) Inventory (2 Pt) T-Tape (2500-2999)
P15338	10	(8) Inventory (3 Pt) (9000-9499)	P15506	12	(8) Inventory (2 Pt) T-Tape (3000-3499)
P15339	10	(8) Inventory (3 Pt) (9500-9999)	P15507	12	(8) Inventory (2 Pt) T-Tape (3500-3999)
P15360	12	(8) Inventory (2 Pt) (0000-0499)	P15508	12	(8) Inventory (2 Pt) T-Tape (4000-4499)
P15361	12	(8) Inventory (2 Pt) (0500-0999)	P15509	12	(8) Inventory (2 Pt) T-Tape (4500-4999)
P15362	12	(8) Inventory (2 Pt) (1000-1499)	P15510	12	(8) Inventory (2 Pt) T-Tape (5000-5499)
P15363	12	(8) Inventory (2 Pt) (1500-1999)	P15511	12	(8) Inventory (2 Pt) T-Tape (5500-5999)
P15364	12	(8) Inventory (2 Pt) (2000-2499)	P15512	12	(8) Inventory (2 Pt) T-Tape (6000-6499)
P15365	12	(8) Inventory (2 Pt) (2500-2999)	P15513	12	(8) Inventory (2 Pt) T-Tape (6500-6999)
P15366	12	(8) Inventory (2 Pt) (3000-3499)	P15514	12	(8) Inventory (2 Pt) T-Tape (7000-7499)
P15367	12	(8) Inventory (2 Pt) (3500-3999)	P15515	12	(8) Inventory (2 Pt) T-Tape (7500-7999)
P15368	12	(8) Inventory (2 Pt) (4000-4499)	P15516	12	(8) Inventory (2 Pt) T-Tape (8000-8499)
P15369	12	(8) Inventory (2 Pt) (4500-4999)	P15517	12	(8) Inventory (2 Pt) T-Tape (8500-8999)
P15380	11	(8) Inventory (2 Pt) (10,000-10,499)	P15518	12	(8) Inventory (2 Pt) T-Tape (9000-9499)
P15381	11	(8) Inventory (2 Pt) (10,500-10,999)	P15519	12	(8) Inventory (2 Pt) T-Tape (9500-9999)
P15382	11	(8) Inventory (2 Pt) (11,000-11,499)	P15530	12	(8) Inventory (2 Pt) T-Tape (0000-0499)
P15383	11	(8) Inventory (2 Pt) (11,500-11,999)	P15531	12	(8) Inventory (2 Pt) T-Tape (0500-0999)
P15384	11	(8) Inventory (2 Pt) (12,000-12,499)	P15532	12	(8) Inventory (2 Pt) T-Tape (1000-1499)
P15385	11	(8) Inventory (2 Pt) (12,500-12,999)	P15533	12	(8) Inventory (2 Pt) T-Tape (1500-1999)
P15386	11	(8) Inventory (2 Pt) (13,000-13,499)	P15534	12	(8) Inventory (2 Pt) T-Tape (2000-2499)
P15387	11	(8) Inventory (2 Pt) (13,500-13,999)	P15535	12	(8) Inventory (2 Pt) T-Tape (2500-2999)
P15388	11	(8) Inventory (2 Pt) (14,000-14,499)	P15536	12	(8) Inventory (2 Pt) T-Tape (3000-3499)
P15389	11	(8) Inventory (2 Pt) (14,500-14,999)	P15537	12	(8) Inventory (2 Pt) T-Tape (3500-3999)
P15390	11	(8) Inventory (2 Pt) (15,000-15,499)	P15538	12	(8) Inventory (2 Pt) T-Tape (4000-4499)
			P15539	12	(8) Inventory (2 Pt) T-Tape (4500-4999)
			P15540	12	(8) Inventory (2 Pt) T-Tape (5000-5499)
			P15541	12	(8) Inventory (2 Pt) T-Tape (5500-5999)
			P15542	12	(8) Inventory (2 Pt) T-Tape (6000-6499)

INDEX

Item No.	Page	Description	Item No.	Page	Description
P15543	12	(8) Inventory (2 Pt) T-Tape (6500-6999)			
P15544	12	(8) Inventory (2 Pt) T-Tape (7000-7499)	P18111	33	Loose Knotted White Elastic
P15545	12	(8) Inventory (2 Pt) T-Tape (7500-7999)			
P15546	12	(8) Inventory (2 Pt) T-Tape (8000-8499)	P18310	25	7/8" Key Rings
P15547	12	(8) Inventory (2 Pt) T-Tape (8500-8999)			
P15548	12	(8) Inventory (2 Pt) T-Tape (9000-9499)	P18412	33	Loose Wire 12" x 21 Gauge
P15549	12	(8) Inventory (2 Pt) T-Tape (9500-9999)	P18432	33	Loose Wire 12" x 23 Gauge
			P18462	33	Loose Wire 12" x 26 Gauge
P15552	9	(8) Inventory Lt. Green (2000-2999)	P18462-500	33	Loose Wire 12" x 26 Gauge
			P18467	33	Loose Wire 7 1/2" x 26 Gauge
P15580	12	(8) Inventory (3 Pt) T-Tape (0000-0499)	P18505	33	Copper Parcel Hook
P15581	12	(8) Inventory (3 Pt) T-Tape (0500-0999)	P18541	33	Diamond Deadlock, Sharp
P15582	12	(8) Inventory (3 Pt) T-Tape (1000-1499)	P18542	33	Diamond Deadlock, Blunt
P15583	12	(8) Inventory (3 Pt) T-Tape (1500-1999)	P18543	33	Diamond Deadlock, Semi-Blunt
P15584	12	(8) Inventory (3 Pt) T-Tape (2000-2499)	P18547	33	Oval Deadlock, Sharp
P15585	12	(8) Inventory (3 Pt) T-Tape (2500-2999)	P18548	33	Oval Deadlock, Blunt
P15586	12	(8) Inventory (3 Pt) T-Tape (3000-3499)	P18550	33	Meat Hook
P15587	12	(8) Inventory (3 Pt) T-Tape (3500-3999)			
P15588	12	(8) Inventory (3 Pt) T-Tape (4000-4499)	P18670	31	(5) Duplicate Tag (000-499)
P15589	12	(8) Inventory (3 Pt) T-Tape (4500-4999)	P18671	31	(5) Duplicate Tag (500-999)
P15605	9	(8) Inventory Orange (5000-5999)	P18900	31	Duplicate Coat Check (000-499)
P15606	9	(8) Inventory Orange (6000-6999)	P18901	31	Duplicate Coat Check (500-999)
P15607	9	(8) Inventory Orange (7000-7999)			
P15720	11	(8) Inventory (3 Pt) (0000-0499)	P18910	31	Triplicate Coat Check (000-499)
P15721	11	(8) Inventory (3 Pt) (0500-0999)	P18911	31	Triplicate Coat Check (500-999)
P15722	11	(8) Inventory (3 Pt) (1000-1499)			
P15723	11	(8) Inventory (3 Pt) (1500-1999)	P18920	31	3 Part Coat Room Check-Blue
P15724	11	(8) Inventory (3 Pt) (2000-2499)	P18921	31	3 Part Coat Room Check-Pink
P15725	11	(8) Inventory (3 Pt) (2500-2999)	P18922	31	3 Part Coat Room Check-Yellow
P15726	11	(8) Inventory (3 Pt) (3000-3499)	P18923	31	3 Part Coat Room Check-Green
P15727	11	(8) Inventory (3 Pt) (3500-3999)	P18924	31	3 Part Coat Room Check-Orange
P15728	11	(8) Inventory (3 Pt) (4000-4499)			
P15729	11	(8) Inventory (3 Pt) (4500-4999)	P18930	31	Coat Room Check-White
P15730	11	(8) Inventory (3 Pt) (5000-5499)	P18931	31	Coat Room Check-Lt. Blue
P15731	11	(8) Inventory (3 Pt) (5500-5999)	P18932	31	Coat Room Check-Red
P15732	11	(8) Inventory (3 Pt) (6000-6499)	P18933	31	Coat Room Check-Orange
P15733	11	(8) Inventory (3 Pt) (6500-6999)			
P15734	11	(8) Inventory (3 Pt) (7000-7499)	P18940	28	Valet Parking Claim Check
P15735	11	(8) Inventory (3 Pt) (7500-7999)	P18941	28	Parking Claim Check
P15736	11	(8) Inventory (3 Pt) (8000-8499)	P18942	28	Valet Parking Tag
P15737	11	(8) Inventory (3 Pt) (8500-8999)			
P15738	11	(8) Inventory (3 Pt) (9000-9499)	P18950	29	Luggage Tag
P15739	11	(8) Inventory (3 Pt) (9500-9999)			
P15740	11	(8) Inventory (3 Pt) (10,000-10,499)	P18951	30	Baggage ID Tag w/T-Tape
P15741	11	(8) Inventory (3 Pt) (10,500-10,999)	P18952	30	Cohesive Bag Tag
P15742	11	(8) Inventory (3 Pt) (11,000-11,499)	P18953	30	(6) Baggage Claim Check English Version
P15743	11	(8) Inventory (3 Pt) (11,500-11,999)	P18954	30	(6) Baggage Claim Check Spanish Version
P15744	11	(8) Inventory (3 Pt) (12,000-12,499)			
P15745	11	(8) Inventory (3 Pt) (12,500-12,999)	P18960	32	(7) Lost and Found
P15746	11	(8) Inventory (3 Pt) (13,000-13,499)			
P15747	11	(8) Inventory (3 Pt) (13,500-13,999)	P55500	25	Auto ID Tag, Red/Grn (000-999)
P15748	11	(8) Inventory (3 Pt) (14,000-14,499)	P55501	25	Auto ID Tag, Red/Grn (1000-1999)
P15749	11	(8) Inventory (3 Pt) (14,500-14,999)	P55502	25	Auto ID Tag, Red/Grn (2000-2999)
P15750	11	(8) Inventory (3 Pt) (15,000-15,499)	P55503	25	Auto ID Tag, Red/Grn (3000-3999)
P15751	11	(8) Inventory (3 Pt) (15,500-15,999)	P55504	25	Auto ID Tag, Red/Grn (4000-4999)
P15752	11	(8) Inventory (3 Pt) (16,000-16,499)	P55505	25	Auto ID Tag, Red/Grn (5000-5999)
P15753	11	(8) Inventory (3 Pt) (16,500-16,999)	P55506	25	Auto ID Tag, Red/Grn (6000-6999)
P15754	11	(8) Inventory (3 Pt) (17,000-17,499)	P55507	25	Auto ID Tag, Red/Grn (7000-7999)
P15755	11	(8) Inventory (3 Pt) (17,500-17,999)	P55508	25	Auto ID Tag, Red/Grn (8000-8999)
P15756	11	(8) Inventory (3 Pt) (18,000-18,499)	P55509	25	Auto ID Tag, Red/Grn (9000-9999)
P15757	11	(8) Inventory (3 Pt) (18,500-18,999)			
P15758	11	(8) Inventory (3 Pt) (19,000-19,499)	P55520	25	(1) Paper Key Tag, White
P15759	11	(8) Inventory (3 Pt) (19,500-19,999)	P55521	25	(1) Paper Key Tag, Yellow
			P55522	25	(1) Paper Key Tag, Red
			P55523	25	(1) Paper Key Tag, Lt. Blue
P17411	8	Envelope	P55524	25	(1) Paper Key Tag, Lt. Green
			P55525	25	(1) Paper Key Tag, Orange
P17500	15	White CSU Poly Pouch			
P17501	15	White Permafiber Poly Pouch	P55550	26	Large Was/Now Tag
P17502		Yellow Permafiber Poly Pouch	P55551	26	Large Blank Tag
			P55560	26	Hold/Sold Tag
P17600	32	Door Hanger Tag			
P18109	33	Unpolished Cotton Loose String 12" x #9	P60300	29	Manifold Bag Tag with 6 Labels (0000-0999)

INDEX

Item No.	Page	Description	Item No.	Page	Description
P60310	28	Valet Parking Check (0000-0999)	P99599	17	White Button Slot Tag
P60320	29	Baggage ID Tag (00000-00999)	P99701	18	(8) Manila Alteration Tag/Button Slot
P60330	28	Valet Parking Check (0000-1000)	P99704	18	(8) White Alteration Tag
P60350	32	Door Hang Tag	P99707	19	(7) Manila Inventory Record Tag
P60501	8	White Pinfeed Tag	PWTWave	27	Tyvek® Wristicket, Blue (000-999)
P60502	8	Tyvek® Pinfeed Tag	PWTFeet	27	Tyvek® Wristicket, Purple (000-999)
P60503	8	White Pinfeed Tag	PWTFun	27	Tyvek® Wristicket, Hot Pink (000-999)
P60504	8	Tyvek® Pinfeed Tag	PWTFlag	27	Tyvek® Wristicket, Red (000-999)
P60505	8	Two Part Carbonless Pinfeed Tag	PWTVIP	27	Tyvek® Wristicket, Orange (000-999)
P60506	8	Blank Interlocking Pinfeed Tag	PWTSCHOOL	27	Tyvek® Wristicket, (000-999)
P72110	20	Warehouse Sale Tag	PWTStp, Yellow	27	Tyvek® Wristicket, Yellow (000-999)
P72202	20	Sale Was/Now Tag	PWTStp, Red	27	Tyvek® Wristicket, Red (000-999)
P72203	20	As Advertised Tag	PWTStp, Green	27	Tyvek® Wristicket, Green (000-999)
P72209	20	Sale Tag	PWTStp, Blue	27	Tyvek® Wristicket, Blue (000-999)
P72301	24	(5) Red Sold Tag, Printed Black	PWTFLRPNK	27	Tyvek® Wristicket, Fl. Pink (000-999)
P72302	24	(5) White Sold Tag, Printed Red	PWTFLRGRN	27	Tyvek® Wristicket, Fl. Green (000-999)
P72303	24	(8) I'm Sold But Tag			
P72305	24	(5) Out of Stock Tag			
P72324	20	Sale Tag, White			
P72326	21	(8) Mfr. Suggested Retail Tag			
P72405	21	(6) Special Sale Tag, White			
P72407	21	(8) Regular Price/Our Price Tag, White			
P72408	21	(6) Sale Sale Tag, White			
P72420	22	Blank Retail Tag			
P72422	22	Anniversary Sale Tag			
P72423	22	Winter Sale Tag			
P72424	22	Spring Sale Tag			
P72425	22	Summer Sale Tag			
P72426	22	Fall Savings Tag			
P72427	22	Going Out of Business Tag			
P72429	23	Grand Opening Tag			
P72430	23	Red/White/Blue Sale Tag			
P72431	23	Holiday/Sale Tag			
P72501	19	Carpet Remnant Tag, White			
P72504	19	Carpet Roll Inventory Tag, White			
P72507	19	No-Rip Tyvek® Carpet Roll Tag			
P95705	23	Tree Sale Tag			
P95708	23	Tree Type Tag			
P95886	24	Rifle ID Tag, Manila			
P96345	17	White Garment Tag			
P96352	17	Yellow Garment Tag			
P96362	17	Lt. Blue Garment Tag			
P96372	17	Pink Garment Tag			
P96382	17	Lilac Garment Tag			
P96392	17	Red Garment Tag			
P96402	17	Grey Garment Tag			
P96412	17	Green Garment Tag			
P96422	17	Dk. Blue Garment Tag			
P96432	17	Beige Garment Tag			
P96442	17	Orange Garment Tag			
P99500	17	White Garment Tag			
P99501	17	Grey Garment Tag			
P99503	17	Red Garment Tag			
P99505	17	Lt. Blue Garment Tag			
P99507	17	Green Garment Tag			
P99509	17	Beige Garment Tag			
P99511	17	Pink Garment Tag			
P99513	17	Orange Garment Tag			
P99515	17	Lilac Garment Tag			
P99517	17	Yellow Garment Tag			
P99545	17	White Garment Tag, Strung			