



Specializing in tag  
and label solutions

800.558.6443  
ssptag.com

DuPont  
Tyvek

Truly Modern

PREFERRED  
PRINTER

Featuring Tag & Labels  
made of DUPONT™ TYVEK®

Water Resistant, Tear Resistant,  
Lightweight and Durable.  
DUPONT™ TYVEK® are trademarks or  
registered trademarks of DuPont.



## TABLE OF CONTENTS

<b>General Information</b> .....	3	<b>Automotive Tags</b>	
<b>Tag Specifications</b> .....	4	• I.D. Tags .....	15
<b>Attachments</b> .....	5	• Paper Key Tags with Rings .....	15
<b>Blank Tags</b>		• Key Rings .....	15
• 10 & 13 pt. Manila .....	6	<b>Production &amp; Safety Tags</b>	
• 13 pt. CSU Colors .....	7	• Metal Rims .....	16
• 13 pt. Fluorescent Colors .....	8	• Safety .....	16
• 15 pt. Oversize .....	8	• Control Tags .....	17
• Tyvek® .....	9	<b>Retail Tags</b>	
• Vinyl .....	9	• Blank Merchandise .....	18
<b>Blank Tags for Special Applications</b>		• Garment .....	18
• Cloth Tags .....	10	• Business Control (layaway, repair, alterations) .....	19
<b>Inventory Tags</b>		• Sale .....	20-21
• Blank Manifold .....	10	• Specialized (general merchandise, sold, hold) .....	22
• 1-Part Inventory .....	11	• Carpet and Furniture .....	23
• Carbonless Inventory (manifold) .....	11-13	<b>Hospitality Tags</b>	
• Carbon Interleaf Inventory (manifold) .....	14	• Baggage .....	24-25
• Specialty Inventory (transfer tape, blank, horizontal) .....	12-14	• Claim Check (coat, claim, lost & found) .....	26
		• Valet Parking .....	27
		<b>Index</b> .....	28-34
		<b>Terms &amp; Conditions of Sale</b> .....	35

## CUSTOM CAPABILITIES

- Tags, Labels & Combinations
- Barcoding & Variable Imaging
- Consecutive Numbering
- Flexographic & Flatbed Letterpress Processes
- Finishing
- Multi-Ply Constructions
- Colored Carbonless

# GENERAL INFORMATION

---

## **Stringing and Wiring**

Save time and effort by having strings or wires added to your stock tag purchase. The strings and wires can be pre-attached or you may purchase them and attach them yourself. See page 5 for our complete selection.

## **Tag Stock**

SU - this stock is sometimes referred to as a Sulfate Stock, uncoated white or manila.  
CSU - starts as an uncoated white stock and then coated with color.

## **Blank Tags**

High quality tags perfect for many different marking uses. 10 pt. SU, 13 pt. SU, and CSU grades available in a variety of standard sizes. Colored and fluorescent tags are available in 13 pt. CSU and are ideal for color coding and easy identification. Many tags are stocked with strings or wires attached. Blank tag colors and descriptions are listed on pages 6-8. All tags are packed in master shipping containers. See price list for additional details. Samples for true colors available upon request, contact [ssp@ssptag.com](mailto:ssp@ssptag.com).

## **Tyvek® Tags**

Manufactured from Spunbonded Olefin, this is our toughest, most durable tag available. Because it is tear resistant, even when wet, and resists chemicals and mildew, this tag is an excellent choice for tough environments. Size and descriptions are listed on page 9.

## **Vinyl Tags**

Produced on 10 Mil calendared vinyl, these tags provide a smooth writing surface on a durable tag. Moisture and oil resistant, high puncture and tear strength. Size and descriptions are listed on page 9.

## **Inventory Tags**

The industry's most complete selection of one-part, two-part and three-part manifold inventory tags aid in keeping inventory in check. The tags are constructed of 10 pt. tag stock, carbon interleaf and bonds, or carbonless stocks. See pages 10-14 for descriptions.

## **Vertical Market/Specialty Tags**

A wide range of tags for various markets including production, hospitality, retail, and furniture as well as specialized markets. Specific tags make it easy to mark inventory, denote prices, identify items and stay organized economically. See pages 15-27.

# Tag Specifications

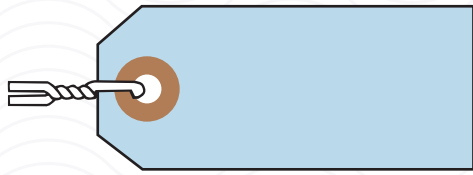

**Metal Wired**

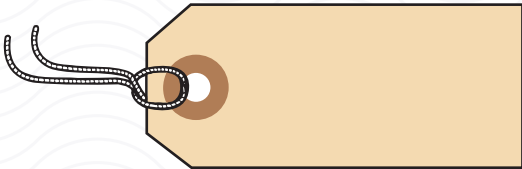

**Looped Strung**

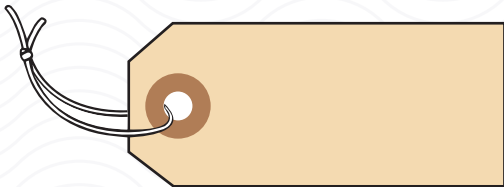

**Knotted Strung**

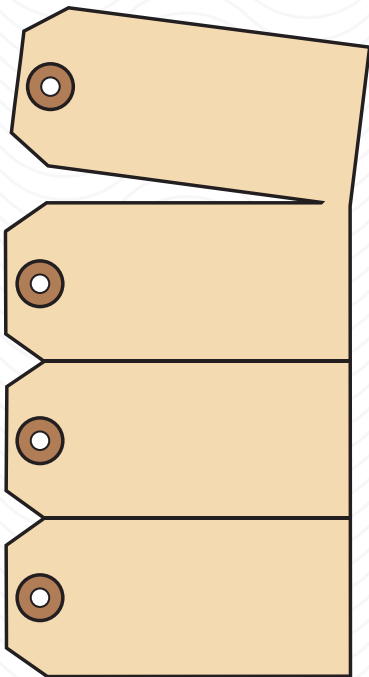

**Gangs of Four**

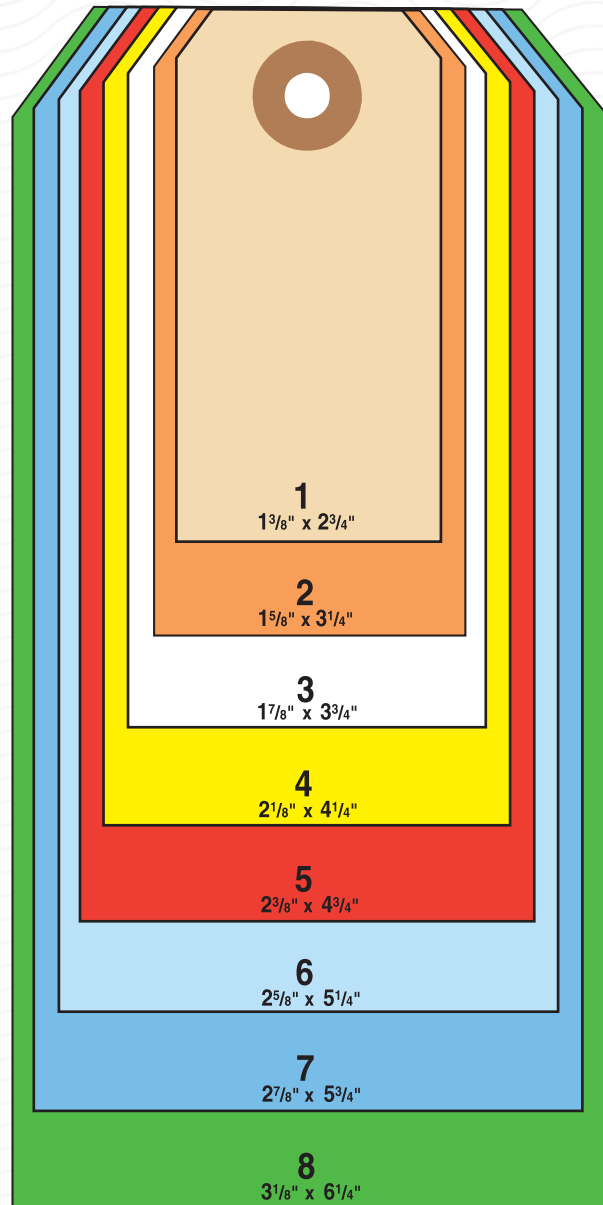

*Stock samples available upon request.*

## **Please Note:**

1. 12"- 26 gauge double wire is used on pre-wired stock products.
2. 23 and 21 heavy gauge wire is also available by special order.

## Loose Strings

Item	Description	Size	Bundle	Ctn
P18109	#9 Unpolished Cotton String	12"	1000	15BDL

P18109



## Loose Elastic

Item	Description	Size	Box	Ctn
P18111	Knotted White Elastic 3" Hole to Knot	3"	1000	5BX

P18111



## Loose Wires

Item	Description	Size	Bundle	Ctn
P18412	Heavy 21 Gauge Wire	12"	1000	15BDL
P18432	Medium 23 Gauge Wire	12"	1000	20BDL
P18462	Light 26 Gauge Wire	12"	1000	25BDL
P18462-500	Light 26 Gauge Wire	12"	500	50BDL
P18467	Light 26 Gauge Wire	7 1/2"	1000	25BDL

P18412  
P18432  
P18462  
P18467

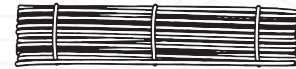

P18505

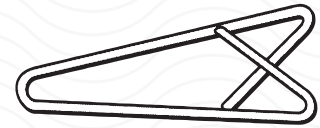

## Copper Parcel Hooks

Item	Description	Size	Box	Ctn
P18505	Copper Coated Steel Wire	2" x 5/8"	1000	10BX



P18541

P18542  
P18543

## 17 Gauge Deadlocks

Item	Description	Box	Ctn
P18541	Diamond, Sharp Point	1000	25BX
P18542	Diamond, Blunt Point	1000	25BX
P18543	Diamond, Semi-blunt Point	1000	25BX
P18547	Oval, Sharp Point	1000	25BX
P18548	Oval, Blunt Point	1000	25BX

P18547

P18548



## Cable Ties

Item	Description	Box	Ctn
P08500	8" Natural Color, 50# Textile	1000	10BX

P08350

P08500

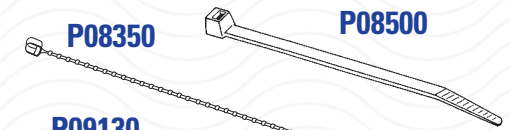

P09130

## Security Attachments

Item	Description	Box	Ctn
P08350	5" Securities	5000	10BX
P09130	5" Security Loops	5000	10BX
P09131	9" Security Loops	5000	10BX

P09121

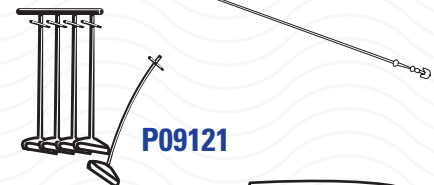

## TACH-IT® Identification System

Item	Description	Box	Ctn
P09100	Mini TACH-IT® 2-Gun	1	
P09110	Standard Mini TACH-IT® 2-Needles	3	
P09111	Heavy Duty Mini TACH-IT® 2-Needles	3	
P09121	1" TACH-IT® Barbs	5000	10BX
P09122	3" TACH-IT® Barbs	5000	10BX

P09100

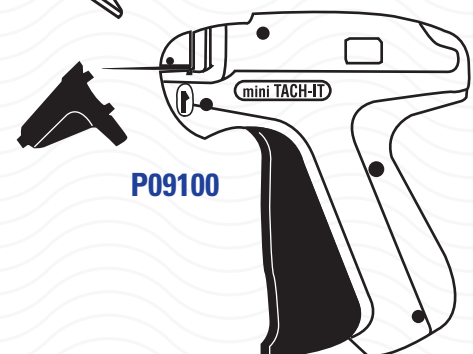



## Manila 10 and 13 pt.

10 pt.	13 pt.	Size	Dimensions	Box	Ctn
P11491	P11301	1	1 3/8" x 2 3/4"	1000	5BX
P11492	P11302	2	1 5/8" x 3 1/4"	1000	5BX
P11493	P11303	3	1 7/8" x 3 3/4"	1000	5BX
P11494	P11304	4	2 1/8" x 4 1/4"	1000	5BX
P11495	P11305	5	2 3/8" x 4 3/4"	1000	5BX
P11496	P11306	6	2 5/8" x 5 1/4"	1000	5BX
P11497	P11307	7	2 7/8" x 5 3/4"	1000	5BX
P11498	P11308	8	3 1/8" x 6 1/4"	1000	5BX

## Manila 13 pt. - String 12" Looped

13 pt.	Size	Dimensions	Box	Ctn
P11501	1	1 3/8" x 2 3/4"	1000	5BX
P11502	2	1 5/8" x 3 1/4"	1000	5BX
P11503	3	1 7/8" x 3 3/4"	1000	5BX
P11504	4	2 1/8" x 4 1/4"	1000	5BX
P11505	5	2 3/8" x 4 3/4"	1000	5BX
P11506	6	2 5/8" x 5 1/4"	1000	5BX
P11507	7	2 7/8" x 5 3/4"	1000	5BX
P11508	8	3 1/8" x 6 1/4"	1000	5BX

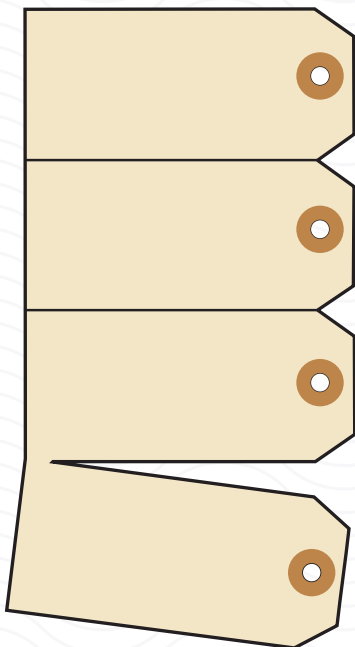

## Manila 10 and 13 pt. - Wired

10 pt.	13 pt.	Size	Dimensions	Box	Ctn
P11691	P11601	1	1 3/8" x 2 3/4"	1000	5BX
P11692	P11602	2	1 5/8" x 3 1/4"	1000	5BX
P11693	P11603	3	1 7/8" x 3 3/4"	1000	5BX
P11694	P11604	4	2 1/8" x 4 1/4"	1000	5BX
P11695	P11605	5	2 3/8" x 4 3/4"	1000	5BX
P11696	P11606	6	2 5/8" x 5 1/4"	1000	5BX
P11697	P11607	7	2 7/8" x 5 3/4"	1000	5BX
P11698	P11608	8	3 1/8" x 6 1/4"	1000	5BX

## Manila 13 pt. - Gangs of Four

13 pt.	Size	Dimensions	Box	Ctn
P11805	5	2 3/8" x 4 3/4"	1000	5BX

## Colors 13 pt. CSU

White	Yellow	Lilac	Red	Size	Dimensions	Box	Ctn
P11311	P11321	P11331	P11341	1	1 3/8" x 2 3/4"	1000	5BX
P11312	P11322	P11332	P11342	2	1 5/8" x 3 1/4"	1000	5BX
P11313	P11323	P11333	P11343	3	1 7/8" x 3 3/4"	1000	5BX
P11314	P11324	P11334	P11344	4	2 1/8" x 4 1/4"	1000	5BX
P11315	P11325	P11335	P11345	5	2 3/8" x 4 3/4"	1000	5BX
P11315W	P11325W	P11335W	P11345W	5	2 3/8" x 4 3/4"	1000	5BX
P11316	P11326	P11336	P11346	6	2 5/8" x 5 1/4"	1000	5BX
--	P11327	--	P11347	7	2 7/8" x 5 3/4"	1000	5BX
P11318	P11328	P11338	P11348	8	3 1/8" x 6 1/4"	1000	5BX
P11318W	P11328W	P11338W	P11348W	8	3 1/8" x 6 1/4"	1000	5BX

Dk. Blue	Lt. Blue	Lt. Green	Dk. Green	Size	Dimensions	Box	Ctn
P11351	P11351L	P11361	P11361D	1	1 3/8" x 2 3/4"	1000	5BX
P11352	P11352L	P11362	P11362D	2	1 5/8" x 3 1/4"	1000	5BX
P11353	P11353L	P11363	P11363D	3	1 7/8" x 3 3/4"	1000	5BX
P11354	P11354L	P11364	P11364D	4	2 1/8" x 4 1/4"	1000	5BX
P11355	P11355L	P11365	P11365D	5	2 3/8" x 4 3/4"	1000	5BX
P11355W	P11355LW	P11365W	P11365DW	5	2 3/8" x 4 3/4"	1000	5BX
P11356	P11356L	P11366	P11366D	6	2 5/8" x 5 1/4"	1000	5BX
P11357	P11357L	P11367	P11367D	7	2 7/8" x 5 3/4"	1000	5BX
P11358	P11358L	P11368	P11368D	8	3 1/8" x 6 1/4"	1000	5BX
P11358W	P11358LW	P11368W	P11368DW	8	3 1/8" x 6 1/4"	1000	5BX

Orange	Pink	Gray	Brown	Size	Dimensions	Box	Ctn
P11371	P11381	P11391	P11911	1	1 3/8" x 2 3/4"	1000	5BX
P11372	P11382	P11392	P11912	2	1 5/8" x 3 1/4"	1000	5BX
P11373	P11383	P11393	P11913	3	1 7/8" x 3 3/4"	1000	5BX
P11374	P11384	P11394	P11914	4	2 1/8" x 4 1/4"	1000	5BX
P11375	P11385	P11395	P11915	5	2 3/8" x 4 3/4"	1000	5BX
P11375W	P11385W	P11395W	P11915W	5	2 3/8" x 4 3/4"	1000	5BX
P11376	P11386	P11396	P11916	6	2 5/8" x 5 1/4"	1000	5BX
P11377	P11387	P11397	P11917	7	2 7/8" x 5 3/4"	1000	5BX
P11378	P11388	P11398	P11918	8	3 1/8" x 6 1/4"	1000	5BX
P11378W	P11388W	P11398W	P11918W	8	3 1/8" x 6 1/4"	1000	5BX



***W indicates pre-attached 12" x 26 gauge double wire.***

## Fluorescent 13 pt. CSU

Red	Chartreuse	Green	Pink	Orange	Size	Dimensions	Box	Ctn
P11701	P11711	P11721	P11731	P11741	1	1 3/8" x 2 3/4"	1000	5BX
P11702	P11712	P11722	P11732	P11742	2	1 5/8" x 3 1/4"	1000	5BX
P11703	P11713	P11723	P11733	P11743	3	1 7/8" x 3 3/4"	1000	5BX
P11704	P11714	P11724	P11734	P11744	4	2 1/8" x 4 1/4"	1000	5BX
P11705	P11715	P11725	P11735	P11745	5	2 3/8" x 4 3/4"	1000	5BX
P11705W	P11715W	P11725W	P11735W	P11745W	5	2 3/8" x 4 3/4"	1000	5BX
P11706	P11716	P11726	P11736	P11746	6	2 5/8" x 5 1/4"	1000	5BX
P11706W	P11716W	P11726W	P11736W	P11746W	6	2 5/8" x 5 1/4"	1000	5BX
P11707	P11717	P11727	P11737	P11747	7	2 7/8" x 5 3/4"	1000	5BX
P11708	P11718	P11728	P11738	P11748	8	3 1/8" x 6 1/4"	1000	5BX
P11708W	P11718W	P11728W	P11738W	P11748W	8	3 1/8" x 6 1/4"	1000	5BX

*\*Colors not representative of true fluorescent colors. To request samples, contact [ssp@ssptag.com](mailto:ssp@ssptag.com).*

## 15 pt. - Oversize Tag

Item	Description	Dimensions	Box	Ctn
P11250	Manila	4" x 8"	500	5BX
P11250W	Manila	4" x 8"	500	5BX
P11251	White	4" x 8"	500	5BX
P11252	Yellow	4" x 8"	500	5BX
P11253	Red	4" x 8"	500	5BX
P11254	Lt. Blue	4" x 8"	500	5BX
P11255	Dk. Blue	4" x 8"	500	5BX
P11256	Lt. Green	4" x 8"	500	5BX
P11257	Orange	4" x 8"	500	5BX
P11258	Pink	4" x 8"	500	5BX

*W indicates pre-attached 12" x 26 gauge double wire.*

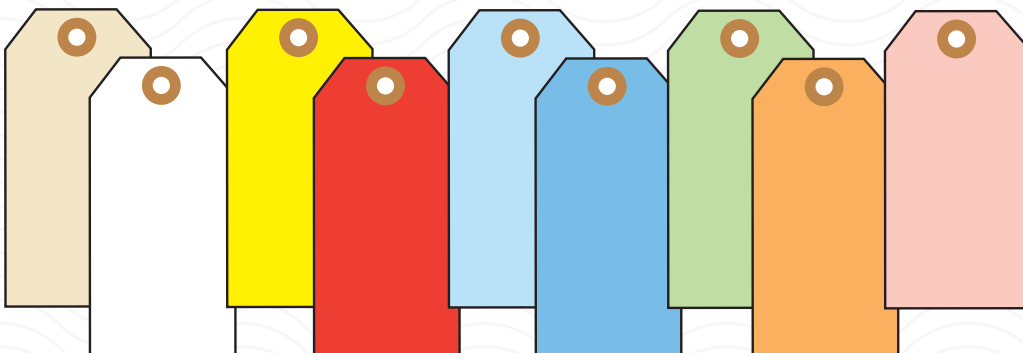

*Stock samples available upon request.*



# Blank Tags For Challenging Environments

## Tyvek® 1079 - with Metal Eyelet

Tyvek® is our toughest, most durable tag. Tear resistant even when wet and resists chemicals and mildew. Perfect for tough environments. 1,000 per box. 5 boxes per carton.

White	Red	Yellow	Green	Blue	Size	Dimensions
P11441					1	1 3/8" x 2 3/4"
P11441W					1	1 3/8" x 2 3/4"
P11442					2	1 5/8" x 3 1/4"
P11442W					2	1 5/8" x 3 1/4"
P11443					3	1 7/8" x 3 3/4"
P11443W					3	1 7/8" x 3 3/4"
P11444					4	2 1/8" x 4 1/4"
P11444W					4	2 1/8" x 4 1/4"
P11445	P11415	P11425	P11435	P11455	5	2 3/8" x 4 3/4"
P11445W	P11415W	P11425W	P11435W	P11455W	5	2 3/8" x 4 3/4"
P11446					6	2 5/8" x 5 1/4"
P11446W					6	2 5/8" x 5 1/4"
P11447					7	2 7/8" x 5 3/4"
P11447W					7	2 7/8" x 5 3/4"
P11448	P11418	P11428	P11438	P11458	8	3 1/8" x 6 1/4"
P11448W	P11418W	P11428W	P11438W	P11458W	8	3 1/8" x 6 1/4"

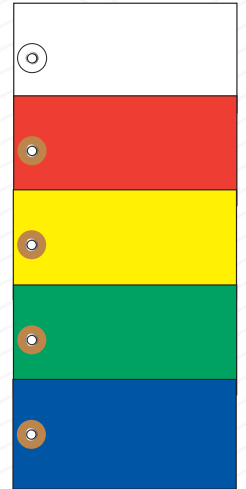

**Tyvek® is a registered trademark of DuPont for its brand of protective material.**  
**W indicates pre-attached 12" x 26 gauge double wire.**

## Colored Vinyl Tags - with Metal Eyelet

Waterproof and ideal for indoor/outdoor conditions. Great for color coding. Available in two sizes and six different colors. Shrinkwrapped in 100's. 1000 per box. 5 boxes per carton.

White	Red	Yellow	Green	Blue	Orange	Size	Dimensions
P14305	P14365	P14325	P14385	P14375	P14395	5	2 3/8" x 4 3/4"
P14308	P14368	P14328	P14388	P14378	P14398	8	3 1/8" x 6 1/4"

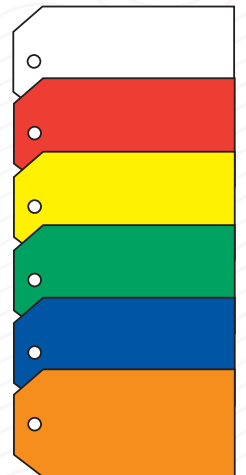

## Colored Vinyl Circle Tags - with Metal Eyelet

Waterproof, and ideal for indoor/outdoor conditions. 3" x 3". Great for color coding. Shrinkwrapped in 100's. 1000 per box. 5 boxes per carton.

Item	Description
P14323	Yellow
P14343	Red
P14353	Blue
P14363	Green
P14373	White

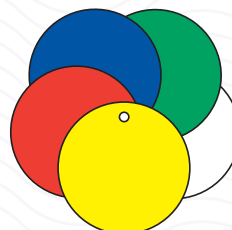

# Blank Tags for Special Applications

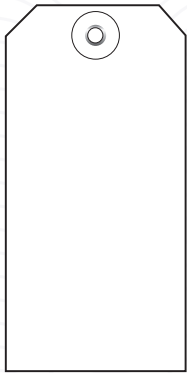

**P11185**

## Cloth Tag - Reinforced with Metal Eyelet

Item	Description	Size	Dimensions	Box	Ctn
P11185	White Anchor Cloth	5	2 3/8" x 4 3/4"	1000	5BX



**P15420 Series**

## Blank Manifold Tag - 3-Part

Blank manifold with two white bond sheets, two carbon interleaf sheets, base of manila stock. Perforated. Numbered in red.  
Standard size 8 tag - 3 1/8" x 6 1/4". 500 per box.

Item	Description
P15420	0000 - 0499
P15421	0500 - 0999
P15422	1000 - 1499
P15423	1500 - 1999
P15424	2000 - 2499
P15425	2500 - 2999
P15426	3000 - 3499
P15427	3500 - 3999
P15428	4000 - 4499
P15429	4500 - 4999

*Stock samples available upon request, contact [ssp@ssptag.com](mailto:ssp@ssptag.com).*

## Inventory Tags - 1-Part

Manila stock, printed in black both sides. Fiber patched and perforated. Duplicate numbered in red. Standard size 8 tag - 3 1/8" x 6 1/4". 1000 per box.

Item	Description
P15400	0000 - 0999
P15401	1000 - 1999
P15402	2000 - 2999
P15403	3000 - 3999
P15404	4000 - 4999
P15405	5000 - 5999
P15406	6000 - 6999
P15407	7000 - 7999
P15408	8000 - 8999
P15409	9000 - 9999
P15410	10000 - 10999
P15411	10000 - 11999
P15412	12000 - 12999
P15413	13000 - 13999
P15414	14000 - 14999
P15415	15000 - 15999
P15416	16000 - 16999
P15417	17000 - 17999
P15418	18000 - 18999
P15419	19000 - 19999

Front

Back

P15400 Series

## 2-Part Carbonless Inventory Tag

White carbonless bond with manila base ply, printed in black. Numbered in red. Standard size 8 tag - 3 1/8" x 6 1/4". 500 per box.

Item	Description
P15360	0000 - 0499
P15361	0500 - 0999
P15362	1000 - 1499
P15363	1500 - 1999
P15364	2000 - 2499
P15365	2500 - 2999
P15366	3000 - 3499
P15367	3500 - 3999
P15368	4000 - 4499
P15369	4500 - 4999

Front

Back

P15360 Series

# Inventory Tags - Carbonless

Carbonless inventory tags help eliminate transcribing errors, when more than one copy is required. Two or three-part carbonless bond with manila base stock, printed in black. Standard size 8 tag - 3 1/8" x 6 1/4". 500 per box.

**Front**

**Back**

## P15530 Series

## 2-Part Carbonless Tag with Removable Self-Adhesive Transfer Tape

Item	Description
P15530	0000 - 0499
P15531	0500 - 0999
P15532	1000 - 1499
P15533	1500 - 1999
P15534	2000 - 2499
P15535	2500 - 2999
P15536	3000 - 3499
P15537	3500 - 3999
P15538	4000 - 4499
P15539	4500 - 4999
P15540	5000 - 5499
P15541	5500 - 5999
P15542	6000 - 6499
P15543	6500 - 6999
P15544	7000 - 7499
P15545	7500 - 7999
P15546	8000 - 8499
P15547	8500 - 8999
P15548	9000 - 9499
P15549	9500 - 9999

## 2-Part Carbonless

Item	Description	Item	Description	Item	Description
P15300	0000 - 0499	P15317	8500 - 8999	P15394	17000 - 17499
P15301	0500 - 0999	P15318	9000 - 9499	P15395	17500 - 17999
P15302	1000 - 1499	P15319	9500 - 9999	P15396	18000 - 18499
P15303	1500 - 1999	P15380	10000 - 10499	P15397	18500 - 18999
P15304	2000 - 2499	P15381	10500 - 10999	P15398	19000 - 19499
P15305	2500 - 2999	P15382	11000 - 11499	P15399	19500 - 19999
P15306	3000 - 3499	P15383	11500 - 11999		
P15307	3500 - 3999	P15384	12000 - 12499		
P15308	4000 - 4499	P15385	12500 - 12999		
P15309	4500 - 4999	P15386	13000 - 13499		
P15310	5000 - 5499	P15387	13500 - 13999		
P15311	5500 - 5999	P15388	14000 - 14499		
P15312	6000 - 6499	P15389	14500 - 14999		
P15313	6500 - 6999	P15390	15000 - 15499		
P15314	7000 - 7499	P15391	15500 - 15999		
P15315	7500 - 7999	P15392	16000 - 16499		
P15316	8000 - 8499	P15393	16500 - 16999		

# Inventory Tags - Carbonless

**Front**

INVENTORY DATE						LOCATION					
QUANTITY		YDS.	FT.	LBS.	PCS.	SHTS.	DOZ.		GR.	GAL.	BRLS.
							SETS		RLS.	BXS.	CTNS.
							M		C	OTHER	
DESCRIPTION											
RAW - PROCESS - FINISHED											
JOB NO.						PART NO.					
COUNTED BY						INDEX NO.					
CHECKED BY											
TAG NO. 1488											

**P15300 Series**

**Front**

INVENTORY DATE						LOCATION					
QUANTITY		YDS.	FT.	LBS.	PCS.	SHTS.	DOZ.		GR.	GAL.	BRLS.
							SETS		RLS.	BXS.	CTNS.
							M		C	OTHER	
DESCRIPTION											
RAW - PROCESS - FINISHED											
JOB NO.						PART NO.					
COUNTED BY						INDEX NO.					
CHECKED BY											
TAG NO. 1488											

**P15720 Series**

**Back**

DATE	IN	OUT	BALANCE

**3-Part Carbonless**

Item	Description	Item	Description
P15720	0000 - 0499	P15737	8500 - 8999
P15721	0500 - 0999	P15738	9000 - 9499
P15722	1000 - 1499	P15739	9500 - 9999
P15723	1500 - 1999	P15740	10000 - 10499
P15724	2000 - 2499	P15741	10500 - 10999
P15725	2500 - 2999	P15742	11000 - 11499
P15726	3000 - 3499	P15743	11500 - 11999
P15727	3500 - 3999	P15744	12000 - 12499
P15728	4000 - 4499	P15745	12500 - 12999
P15729	4500 - 4999	P15746	13000 - 13499
P15730	5000 - 5499	P15747	13500 - 13999
P15731	5500 - 5999	P15748	14000 - 14499
P15732	6000 - 6499	P15749	14500 - 14999
P15733	6500 - 6999		
P15734	7000 - 7499		
P15735	7500 - 7999		
P15736	8000 - 8499		

# Inventory Tags - Carbon Interleaf

Two-part manifold inventory tags help keep your inventory organized and controlled. Numbered in red up to 9999. White bond and one carbon with manila base stock. Printed black. Size 8 - 3 1/8" x 6 1/4". 500 per box.

**Front**

**Back**

INVENTORY DATE LOCATION

QUANTITY YDS. FT. LBS. PCS. SHTS.  
DOZ. GR. GAL. BRLS.  
SETS RLS. BXS. CTNS.  
M C OTHER

DESCRIPTION

RAW - PROCESS - FINISHED

JOB NO. PART NO.

COUNTED BY

CHECKED BY

TAG NO. 1488

OUT BALANCE

INDEX NO.

**P15100 Series**

## 2-Part Carbon Interleaf

Item	Description
P15100	0000 - 0499
P15101	0500 - 0999
P15102	1000 - 1499
P15103	1500 - 1999
P15104	2000 - 2499
P15105	2500 - 2999
P15106	3000 - 3499
P15107	3500 - 3999
P15108	4000 - 4499
P15109	4500 - 4999
P15110	5000 - 5499
P15111	5500 - 5999
P15112	6000 - 6499
P15113	6500 - 6999
P15114	7000 - 7499
P15115	7500 - 7999
P15116	8000 - 8499
P15117	8500 - 8999
P15118	9000 - 9499
P15119	9500 - 9999

## 2-Part Carbon Interleaf Inventory Tag with Removable Self-Adhesive Transfer Tape

**Front**

**Back**

INVENTORY DATE LOCATION

QUANTITY YDS. FT. LBS. PCS. SHTS.  
DOZ. GR. GAL. BRLS.  
SETS RLS. BXS. CTNS.  
M C OTHER

DESCRIPTION

RAW - PROCESS - FINISHED

JOB NO. PART NO.

COUNTED BY

CHECKED BY

TAG NO. 1488

WARNING!  
NOT attach to furniture,  
glass, or other fine finishes.

IN OUT BALANCE

INDEX NO.

**P15500 Series**

Item	Description
P15500	0000 - 0499
P15501	0500 - 0999
P15502	1000 - 1499
P15503	1500 - 1999
P15504	2000 - 2499
P15505	2500 - 2999
P15506	3000 - 3499
P15507	3500 - 3999
P15508	4000 - 4499
P15509	4500 - 4999
P15510	5000 - 5499
P15511	5500 - 5999
P15512	6000 - 6499
P15513	6500 - 6999
P15514	7000 - 7499
P15515	7500 - 7999
P15516	8000 - 8499
P15517	8500 - 8999
P15518	9000 - 9499
P15519	9500 - 9999

## Auto I.D. Tags

Dimensions of 5 1/4" x 6 1/2". Red/Green duplex stock per illustration, printed in black. 1000 per box.

Item	Description
P55500	000-999
P55501	1000-1999
P55502	2000-2999
P55503	3000-3999
P55504	4000-4999
P55505	5000-5999
P55506	6000-6999
P55507	7000-7999
P55508	8000-8999
P55509	9000-9999

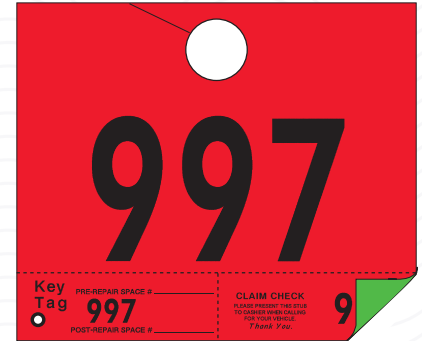

Auto I.D. Tags

## Paper Key Tags with Rings

Dimensions of 1 3/8" x 2 3/4". Printed in black on listed stock colors. 1000 per box, along with 1000 key rings bagged in 250s.

Item	Description
P55520	White
P55521	Yellow
P55522	Red
P55523	Lt. Blue
P55524	Lt. Green
P55525	Orange

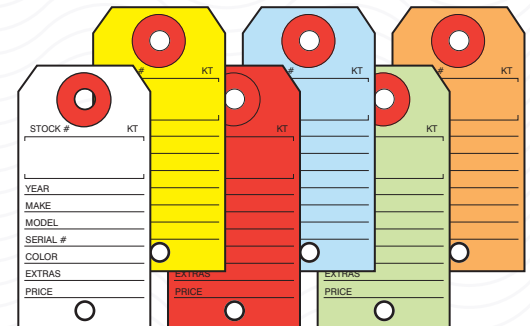

Paper Key Tags with Rings

## Key Rings

250 per bag.

Item	Description
P18310	Metal 7/8"



Key Ring

# Production & Safety Tags

## Metal Rim Tags

Heavy stock and smooth writing surface. Aluminum rims prevent bending. White with knotted string attached. Four sizes available. 500 per box. 12 boxes per carton.

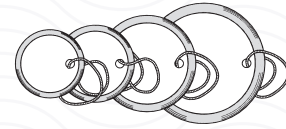

Metal Rim Tags

Item	Description
P14312	1 <sup>5</sup> / <sub>16</sub> " Diameter
P14313	1 1/4" Diameter
P14314	1 9/16" Diameter
P14315	1 7/8" Diameter

### Applications for Production & Safety Tags:

- Property identification
- Property tracking
- Business assets protection
- Accounting procedure assistance
- Insurance procedure assistance
- Special requirements identification
- Quality control

## Safety Tag

Danger - Do Not Operate - White vinyl. Printed in black and red, two sides. Rubber banded in packs of 25. Standard size 8 tag - 3 1/8" x 6 1/4". 500 per box. 10 boxes per carton.

Item	Description
P15050	Danger - Do Not Operate

Front



Back



P15050



## Control Tags - 1-Part

These tags are great for quality control and special requirement identification, in colors indicated, printed in black. Reinforced fiber patch hole. Standard size 5 - 2 3/8" x 4 3/4". 1000 per box. 5 boxes per carton.

Item	Description	Stock
P15016	Inspected Tag	Yellow
P15017	Rejected	Red
P15021	Accepted	Lt. Green

## Control Tags - 2-Part

Colored stock with a matching bond as indicated and carbon interleaf. Fiber patch reinforced hole. Printed and numbered in black. Standard size 5 - 2 3/8" x 4 3/4". 500 per box. 10 boxes per carton.

Item	Description	Stock	Numbers
P15022	Rejected	Red Base/ Pink Bond	000 - 499
P15023	Rejected	Red Base / Pink Bond	500 - 999
P15024	Repair/Rework	Green Base / Lt. Green Bond	000 - 499
P15028	Scrap	Yellow Base /Canary Bond	000 - 499

**INSPECTED**

PART NUMBER \_\_\_\_\_

INSPECTION OK, APPROVED FOR USE \_\_\_\_\_

REPAIRS MADE DURING INSPECTION, APPROVED FOR USE \_\_\_\_\_

RETURN FOR REWORK AND/OR REPAIRS \_\_\_\_\_

RETURN TO VENDOR \_\_\_\_\_

COMMENTS \_\_\_\_\_

DATE \_\_\_\_\_ INITIALS \_\_\_\_\_

**P15016**

**ACCEPTED**

Customer \_\_\_\_\_

W.O. No. \_\_\_\_\_ Date \_\_\_\_\_

No. Pcs. \_\_\_\_\_ Material \_\_\_\_\_

Part No. \_\_\_\_\_ Ser. No. \_\_\_\_\_

Part Name \_\_\_\_\_

Inspector \_\_\_\_\_

Comments \_\_\_\_\_

**P15021 - Green**

**REJECTED**

JOB NO. \_\_\_\_\_ P. O. NO. \_\_\_\_\_

PART NO. \_\_\_\_\_ SERIAL NO. \_\_\_\_\_

PART NAME \_\_\_\_\_

NO. OF PIECES REJECTED \_\_\_\_\_

REASON \_\_\_\_\_

INSPECTOR \_\_\_\_\_ DATE \_\_\_\_\_

**P15017**

**REJECTED** 001

JOB NO. \_\_\_\_\_ P. O. NO. \_\_\_\_\_

PART NO. \_\_\_\_\_ SERIAL NO. \_\_\_\_\_

PART NAME \_\_\_\_\_

NO. OF PIECES REJECTED \_\_\_\_\_

REASON \_\_\_\_\_

INSPECTOR \_\_\_\_\_ DATE \_\_\_\_\_

**P15022 / P15023**

**REPAIRABLE OR REWORK** 001

CUSTOMER \_\_\_\_\_

JOB NO. \_\_\_\_\_ DATE \_\_\_\_\_

PART NO. \_\_\_\_\_ PART NAME \_\_\_\_\_

P.O. NO. \_\_\_\_\_ SER. NO. \_\_\_\_\_

NO. OF PIECES \_\_\_\_\_

DISPOSITION \_\_\_\_\_

INSB \_\_\_\_\_ STAMP \_\_\_\_\_

REASON FOR REWORK (Use reverse side) \_\_\_\_\_

**P15024**

**SCRAP** 001

PRODUCT PART NO. \_\_\_\_\_ DESCRIPTION \_\_\_\_\_

QTY./WT. \_\_\_\_\_ PRODUCT/JOB NO. \_\_\_\_\_ VENDOR \_\_\_\_\_

OPERATOR \_\_\_\_\_ DEPT./WORK CTR. NO. \_\_\_\_\_

REASON \_\_\_\_\_

DISPOSITION \_\_\_\_\_

CHARGE TO ACCT. NO. \_\_\_\_\_

INSPECTED BY \_\_\_\_\_ APPROVED BY \_\_\_\_\_

**P15028**

# Retail - Tags

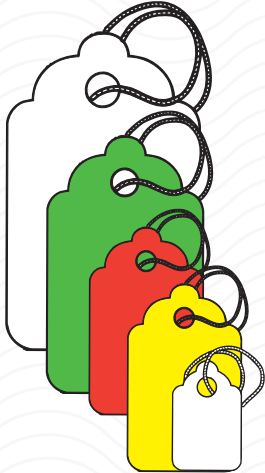

**Merchandise Tags  
Scalloped**

## Merchandise Tags

Scalloped tags in various colors and sizes. Knotted string, various lengths. 1000 per box. 12 boxes per carton.

White	Yellow	Red	Green	Dimensions
P12200				2" x 3 1/4"
P12201	P12421	P12441	P12451	1 3/4" x 2 7/8"
P12202				1 7/16" x 2 3/16"
P12203				1 1/4" x 1 7/8"
P12204				1 1/8" x 1 3/4"
P12205	P12425	P12445	P12455	1 5/16" x 1 1/2"
P12206				7/8" x 1 1/4"
P12207				3/4" x 1 1/8"
P12211				5/8" x 1 5/16"

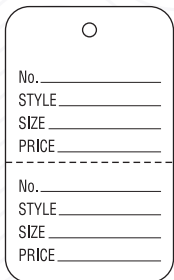

**Large Couponed  
Garment Tags**

## Couponed Garment Tags - Large

White stock printed in black and perforated. Unstrung. 1 3/4" x 2 7/8". 1000 per box. 12 boxes per carton.

Item	Description
P96345	White

*Additional colors available upon request - subject to minimum order.*

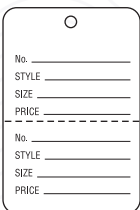

**Small Couponed  
Garment Tags**

## Couponed Garment Tags - Small

White stock printed in black and perforated. Unstrung. 1 1/4" x 1 7/8". 1000 per box. All others are 24 boxes per carton.

Item	Description
P99500	White

*Additional colors available upon request - subject to minimum order.*

Quickly and easily attach garment tags with our Mini TACH-IT® 2 gun and assortment of needles and security ties. See page 5 for details.

# Retail - Business Control Tags

## Layaway Tags - Strung

Manila stock, printed in black both sides. Perforated, patched and triplicate numbered in red. Looped string attached. 3 1/8" x 7". 500 per box. 10 boxes per carton.

Item	Description
P15040	000-499

## Repair Tags - Strung

Manila stock, printed in black one side. Perforated, patched with looped string and duplicate numbered in red. Size 6 - 2 5/8" x 5 1/4". 1000 per box. 5 boxes per carton.

Item	Description
P15030	000-999
P15032	1000-1999

## Alteration Tags - Strung

Alteration tag with button slot. Manila stock, printed in black both sides. Perforated, patched and duplicate numbered in red. Size 8 - 3 1/8" x 6 1/4". 1000 per box. 5 boxes per carton.

Item	Description
P99701	Numbers pulled at random in sequence.

## Alteration Tags

Alteration tag with looped string. White stock, printed in brown one side. Perforated with matching patch. Duplicate numbered in red. Size 8 - 3 1/8" x 6 1/4". 1000 per box. 5 boxes per carton.

Item	Description
P99704	Numbers pulled at random in sequence.

**Front**

**LAY-AWAY TICKET NO. 111**

Date \_\_\_\_\_ Name \_\_\_\_\_  
 Address \_\_\_\_\_ Article \_\_\_\_\_ Sold by \_\_\_\_\_  
 Retail Price \_\_\_\_\_ Tax \_\_\_\_\_ Total \_\_\_\_\_  
 Total Paid \_\_\_\_\_ TICKET NO. 111  
 Name \_\_\_\_\_  
 Address \_\_\_\_\_ Clerk No. \_\_\_\_\_  
 Article \_\_\_\_\_

**PAYMENTS MADE**

Date	When Paid	Amount	Balance	Rec'd By

**Back**

**CUSTOMER'S IDENTIFICATION STRIP**  
**LAY-AWAY TICKET NO. 111**

This stub is to be retained until final payment is received upon receipt of merchandise. If merchandise is not fully paid for and called for on or before \_\_\_\_\_ it will be returned to stock unless special arrangements are made.

SOLD BY \_\_\_\_\_

1. I understand that this merchandise will be held for me in the Lay-Away Dept. and I agree to pay the balance due by \_\_\_\_\_.

2. I agree to pay \$ \_\_\_\_\_ Every \_\_\_\_\_.

3. I understand that if the merchandise is not fully paid for and called for on or before \_\_\_\_\_ it will be returned to stock unless special arrangements are made.

MR. \_\_\_\_\_  
 LOT NO. \_\_\_\_\_ DATE REC'D. \_\_\_\_\_

REMARKS \_\_\_\_\_

**PAYMENTS MADE**

Date	When Paid	Amount	Balance	Rec'd By

**P15040**

**ALTERATION TAG**

**No. 222862**

Date \_\_\_\_\_

Name \_\_\_\_\_

Address \_\_\_\_\_

Garment \_\_\_\_\_

Salesperson \_\_\_\_\_ Dept. \_\_\_\_\_

W/I Call  Send

CHARGE  CASH  C.O.D.

Amount of Sale \_\_\_\_\_

Tax \_\_\_\_\_

Alteration Charge \_\_\_\_\_

Total \_\_\_\_\_

Deposit \_\_\_\_\_

Balance Due \_\_\_\_\_

NOTE ALTERATIONS ON REVERSE SIDE

**CUSTOMER'S CLAIM CHECK**

**No. 222862**

To Be Ready \_\_\_\_\_ Amt. of Sale \_\_\_\_\_

Tax \_\_\_\_\_

Alt. Chgs. \_\_\_\_\_

Total \_\_\_\_\_

Dept. \_\_\_\_\_

Deposit \_\_\_\_\_

Balance Due \_\_\_\_\_

Salesperson \_\_\_\_\_

NO GOODS DELIVERED WITHOUT THIS CHECK

**P99704**

**Front**

**ALTERATION TAG**

**000001**

**STATE ALTERATIONS ON BACK**

Date \_\_\_\_\_

Name \_\_\_\_\_

Address \_\_\_\_\_

Garment \_\_\_\_\_

Price Tax Alt. Total \_\_\_\_\_

Sold by \_\_\_\_\_ Paid \_\_\_\_\_

**When** To be Done \_\_\_\_\_  
 Will Call 1 \_\_\_\_\_ Due \_\_\_\_\_

Remarks \_\_\_\_\_

OWNER \_\_\_\_\_

**000001** Date \_\_\_\_\_

Garment \_\_\_\_\_

Price Tax Alt. Total \_\_\_\_\_

Sold by \_\_\_\_\_ Paid \_\_\_\_\_

When F. finished \_\_\_\_\_ Due \_\_\_\_\_

NO GOODS DELIVERED WITHOUT THIS CHECK

**Back**

**COAT**

Neck \_\_\_\_\_ Length \_\_\_\_\_  
 Sleeve \_\_\_\_\_ Collar \_\_\_\_\_  
 Bust \_\_\_\_\_ Waist \_\_\_\_\_  
 Length \_\_\_\_\_  
 Waist \_\_\_\_\_  
 Length \_\_\_\_\_  
 Bottom \_\_\_\_\_  
 Waist Cuffs \_\_\_\_\_

**VEST**

Chest \_\_\_\_\_  
 Waist \_\_\_\_\_

**TROUSERS**

Waist \_\_\_\_\_ Thigh \_\_\_\_\_  
 Length \_\_\_\_\_ Knee \_\_\_\_\_  
 Bottom \_\_\_\_\_  
 Waist Cuffs \_\_\_\_\_

**P99701**

**268** Date \_\_\_\_\_

Name \_\_\_\_\_

Address \_\_\_\_\_

Article \_\_\_\_\_

Date Promised \_\_\_\_\_

Price \_\_\_\_\_

Work to be done \_\_\_\_\_

COUPON NO. \_\_\_\_\_ DATE PROMISED \_\_\_\_\_

**268**

Article \_\_\_\_\_

Price \_\_\_\_\_

**P15030**

**P15032**

# Retail - Sale Tags

## Retail Sale Tags - Small

Item	Description	Dimensions	Box	Ctn
P15208	Sale Price - Yellow stock, printed in red. Knotted string.	1 5/8" x 2 3/4"	1000	12BX
P15251	Special Sale - White stock, printed in red. Knotted string.	1 3/4" x 2 7/8"	500	22BX

## Retail Sale Tags - Medium

Item	Description	Size	Dimensions	Box	Ctn
P72003	General - White stock, printed in blue. Knotted string.	--	3" x 5 1/2"	500	10BX
P15220	Special Sale - White stock, printed in red. 3 1/2" knife slit.	8	3 1/8" x 6 1/4"	500	10BX
P72405	Special Sale - White stock, printed in red & blue. 3 1/2" knife slit.	6	2 5/8" x 5 1/4"	500	10BX
P72407	Reg Price/Our Price - White stock, printed in red. 3 1/2" knife slit.	8	3 1/8" x 6 1/4"	500	10BX
P72408	Sale Sale Sale - White stock, printed in red & yellow. 3 1/2" knife slit.	6	2 5/8" x 5 1/4"	500	10BX



P15208



P15251

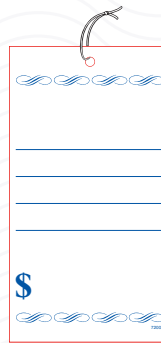

P72003

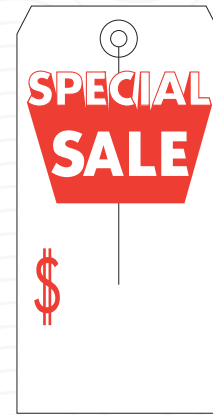

P15220



P72405



P72407



P72408

## Retail Sale Tags - Large

Item	Description	Dimensions	Box	Ctn
P15088	Sale - White stock, printed in red. 3 ½" knife slit.	5" x 7"	500	5BX
P72202	Was/Now - White stock, printed in red. 3 ½" knife slit.	4" x 8"	500	4BX
P72209	Sale - Fluorescent red stock, printed in black. 3 ½" knife slit.	4" x 8"	500	4BX
P72324	Sale - White stock, printed in red & black. 3 ½" knife slit.	9 ½" x 6 ⅛"	250	10BX



P15088



P72202



P72209



P72324

# Retail - Specialized Tags

## General Merchandise Tags

Item	Description	Size	Dimensions	Box	Ctn
P72303	I'm Sold But - White stock, printed in red. 3 1/2" knife slit.	8	3 1/8" x 6 1/4"	500	10BX
P95886	Rifle ID - Manila stock, printed in brown, prestrung.	3	1 7/8" x 3 3/4"	500	10BX

## Sold/Hold Tags

Item	Description	Size	Dimensions	Box	Ctn
P72301	Sold - Red stock, printed in black. 3 1/2" knife slit.	5	2 3/8" x 4 3/4"	1000	5BX
P72302	Sold - White stock, in printed red. 3 1/2" knife slit.	5	2 3/8" x 4 3/4"	1000	5BX
P15166	Hold - White stock, printed in blue. 3 1/2" knife slit.	5	2 3/8" x 4 3/4"	500	10BX



P72303



P95886



P72301



P72302

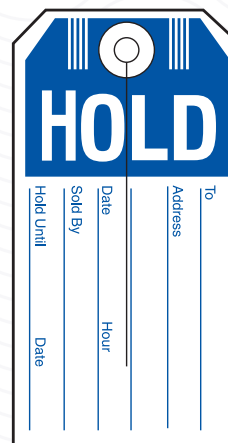

P15166

# Retail - Carpet and Furniture Tags

## Carpet Tags

Item	Description	Dimensions	Box	Ctn
P72501	Remnant - White stock, printed in red.	5 1/4" x 7"	500	5BX
P72504	Roll - White stock, printed in red, metal reinforced eyelet.	5 1/4" x 7"	500	5BX
P72507	Roll - Tyvek® stock, printed in red, metal reinforced eyelet.	5 1/4" x 7"	500	5BX
P99707	Inventory Record - Manila stock, printed in black.	2 7/8" x 5 3/4"	1000	5BX

## Furniture Tags

Item	Description	Dimensions	Box	Ctn
P15083	Blue Price - Lt. blue stock, printed in blue ink both sides. Knotted string.	2 1/8" x 3 1/8"	500	22BX
P15084	Ivory Price - Ivory stock, printed in red and brown. Knotted string.	2 1/8" x 3 1/8"	500	22BX
P15086	Utility - Buff stock, printed in brown. Knotted string.	2 1/8" x 3 1/8"	500	22BX



P72501

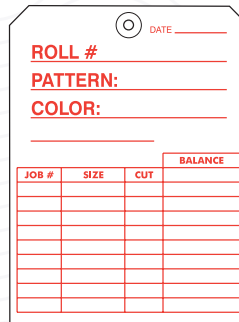

P72504  
P72507



P99707

Front

Back

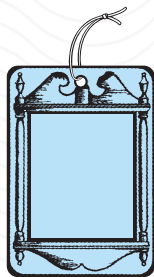

P15083

The back of the tag showing a table with columns "Stock" and "Qty." and rows of numbers.

Stock	Qty.
44	43
40	38
35	33
30	28
25	23
20	18
15	13
10	8
5	3



P15084

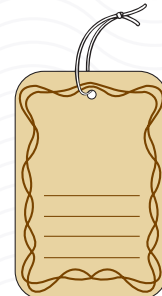

P15086

# Hospitality Baggage Tags

## Bag Identification Tags

Item	Description	Numbers	Dimensions	Box	Ctn
P18950	White stock, printed in black. Red numbering. Knotted string attached.	000-999	2 1/2" x 4 1/4"	1000	5BX
P60300	Perforated numbered guest check. Yellow tag and label stock printed in black. Manifold construction with six matching numbers. Elastic string attached.	0000-0999	2 1/2" x 6 1/2"	1000	5BX
P60320	Constructed of tear-proof durable stock printed in green on white stock, ensuring easy and reliable identification. Duplicate black numbering.	00000-00999	1 1/2" x 11"	1000	5BX



**P18950**

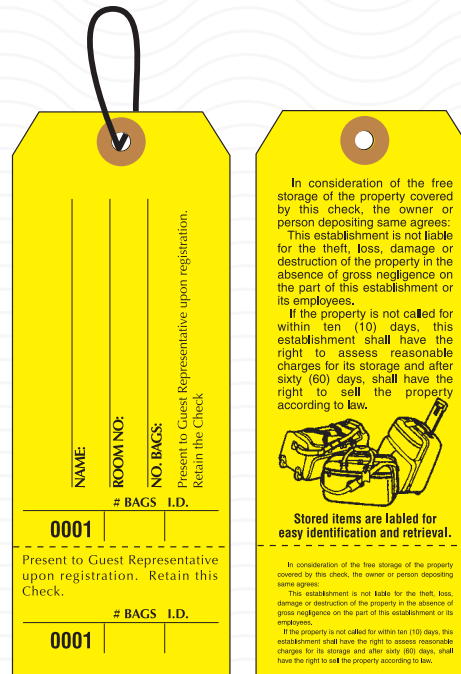
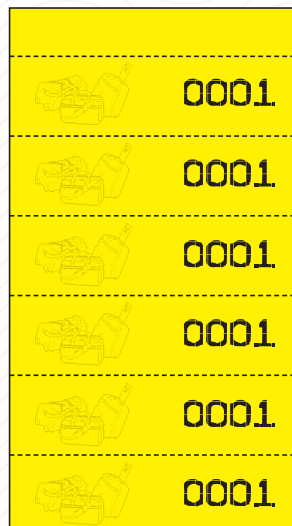

**P60300**



**P60320**



# Hospitality Baggage Tags

## Baggage ID Tag w/Transfer Tape

Item	Description	Numbers	Dimensions	Box	Ctn
P18951	White stock, printed in blue. Red numbering. Transfer tape on back.	000-999	1 ¼" x 10 ½"	1000	5BX

## Cohesive Bag Tag

Item	Description	Numbers	Dimensions	Box	Ctn
P18952	White, cohesive stock, printed in blue. Red numbering.	000-999	1 ½" x 11"	1000	5BX

## Baggage Claim Check Tags with Knotted String

Item	Description	Numbers	Dimensions	Box	Ctn
P18953	White stock, printed in blue. Red numbering. Size 6 tag.	000-999	2 5/8" x 5 ¼"	1000	5BX

<p style="text-align: right;"><b>001</b></p> <p>Name _____</p> <p>Room _____ Pieces _____</p> <p>Date Left _____</p> <p>Date to Pick-up _____</p>	<h3>BAGGAGE ID TAG</h3>	<p style="text-align: left;"><b>001</b></p> <p style="writing-mode: vertical-rl; transform: rotate(180deg);">Claim Check</p> <p style="font-size: 8px;">This check is subject to the following conditions. 1. Property may be delivered to any person presenting check, but will not be delivered without check. 2. Owner(s) of this property assumes all risk of damage by fire, water, theft, or other causes. 3. Liability for above risks is limited to amount set by law unless a separate agreement has been made. 4. Baggage left an unreasonable length of time will be disposed of in accordance with the law.</p>
---	-------------------------	---

**P18951**

<p style="text-align: right;"><b>001</b></p> <p style="writing-mode: vertical-rl; transform: rotate(180deg);">CLAIM CHECK</p> <p style="writing-mode: vertical-rl; transform: rotate(180deg);">Present This stub to Claim Your Bag.</p> <p style="font-size: 8px;">The Hotel is not liable for loss or damage to the property as a result of negligence, or otherwise, unless it appears that the loss or damage was caused by the hotel's gross negligence or misrepresentation on the part of the hotel or its employees.</p>	<h3>BAGGAGE IDENTIFICATION TAG</h3>	<p style="text-align: left;"><b>001</b></p>								
<table border="1" style="width: 100%; border-collapse: collapse;"> <tr> <td colspan="2">NAME:</td> <td colspan="2">ROOM #:</td> </tr> <tr> <td>CHECKED BY:</td> <td>PIECES:</td> <td>DATE LEFT:</td> <td>DATE TO PICKUP:</td> </tr> </table>		NAME:		ROOM #:		CHECKED BY:	PIECES:	DATE LEFT:	DATE TO PICKUP:	
NAME:		ROOM #:								
CHECKED BY:	PIECES:	DATE LEFT:	DATE TO PICKUP:							

**P18952**

**Front**

**Back**

**P18953**

# Hospitality Claim Check Tags

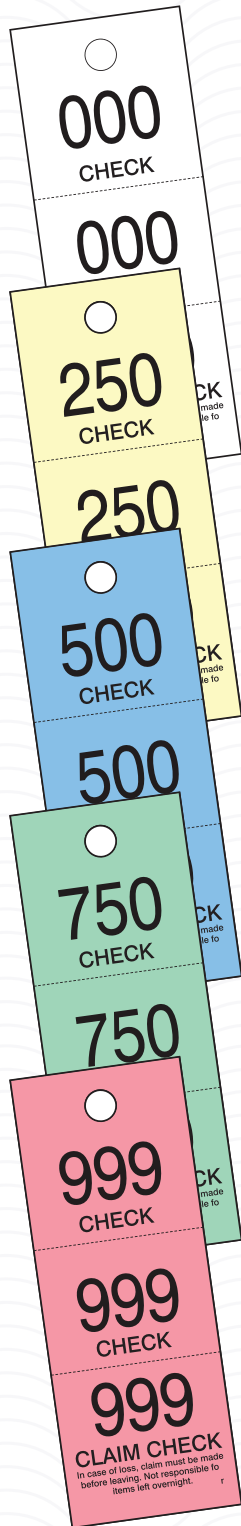

**P18980 through  
P18984**

## Claim Check Tags

90# Index, various colors, printed in black. Large  $\frac{3}{8}$ " punch hole to fit over hanger with 2 perforations for multiple items. Size - 2" x 5  $\frac{1}{4}$ ". Large black numbering sequence is 000-999. 1000 per box. 10 boxes per carton.

Item	Description
P18980	White
P18981	Yellow
P18982	Lt. Blue
P18983	Lt. Green
P18984	Cherry

## Duplicate Tags - Looped String

Manila stock, printed in black. Size 5 - 2  $\frac{3}{8}$ " x 4  $\frac{3}{4}$ ". Duplicate numbers in black. "RETAIN THIS CHECK" in red. Fiber patched and looped string. 500 per box. 10 boxes per carton.

Item	Description
P18670	000-499
P18671	500-999

## Property Tag

Manila stock, printed in black. Size 6 - 2  $\frac{5}{8}$ " x 5  $\frac{1}{4}$ ". Perforated with knotted string. 500 per box. 10 boxes per carton.

Item	Description
P18961	Lost & Found

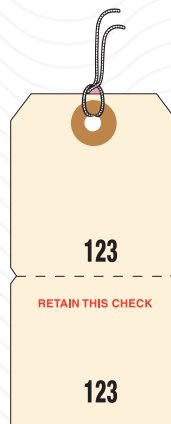

**P18670**

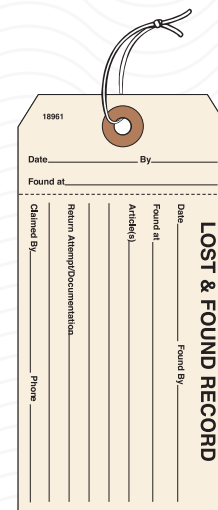

**P18961**

# Hospitality Parking - Valet Tags

## Valet Parking/Claim Check/Tag

Item	Description	Numbers	Dimensions	Box	Ctn
P18940	White stock, printed in black. Die-cut for hanging.	0001-1000	9 1/2" x 5"	1000	1BX
P18941	White stock, printed in black. Red numbering.	000-999	6 3/4" x 2 1/2"	1000	10BX
P18942	White stock, printed in black, both sides. Red numbering. Die-cut for hanging.	000-999	9 1/2" x 2 3/4"	1000	5BX
P18945	White stock, printed in black. Die-cut for hanging.	0000- 0499	3 1/8" x 4 3/4"	1000	10BX
P60310	White stock, printed in blue. Red numbering. Two perforations, die-cut for hanging.	0000-0999	2 1/2" x 10 1/2"	1000	5BX
P60330	White stock, printed in green & yellow. Triplicate black numbering. Two perforations, die-cut for hanging.	00000-00999	2 1/2" x 12"	1000	5BX



P18940

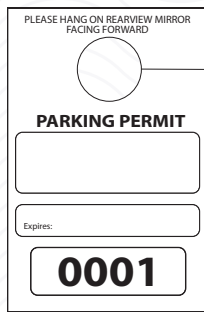

P18945



P18941

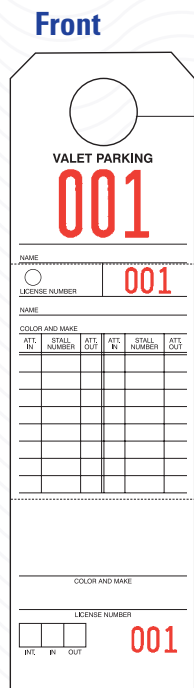

P18942

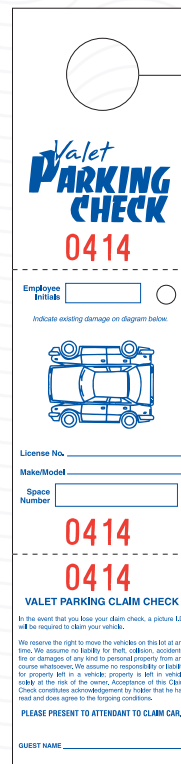
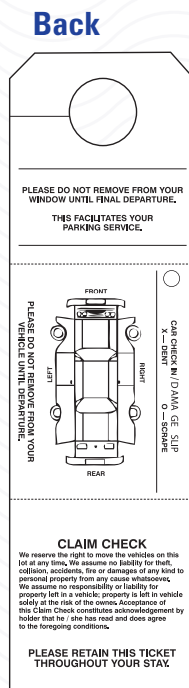

P60310

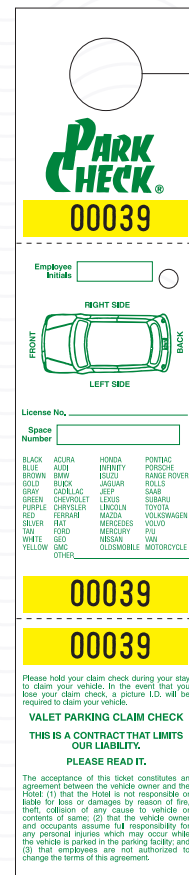

P60330

# Index

Item No.	Page	Description	Item No.	Page	Description
P08350	5	5" Securities	P11334	7	(4) 13 CSU Lilac Tag
P08500	5	8" Cable Tie	P11335	7	(5) 13 CSU Lilac Tag
P09100	5	Mini TACH-IT® 2 Gun	P11335W	7	(5) 13 CSU Lilac Tag, Wired
P09110	5	TACH-IT® Needles, Standard	P11336	7	(6) 13 CSU Lilac Tag
P09111	5	TACH-IT® Needles, Heavy Duty	P11338	7	(8) 13 CSU Lilac Tag
P09121	5	1" TACH-IT® Barbs	P11338W	7	(8) 13 CSU Lilac Tag, Wired
P09122	5	3" TACH-IT® Barbs			
P09130	5	5" Security Loops	P11341	7	(1) 13 CSU Red Tag
P09131	5	9" Security Loops	P11342	7	(2) 13 CSU Red Tag
			P11343	7	(3) 13 CSU Red Tag
P11185	10	(5) Cloth Tag w/Eyelet	P11344	7	(4) 13 CSU Red Tag
			P11345	7	(5) 13 CSU Red Tag
P11250	8	15 SU Manila Tag Oversize	P11345W	7	(5) 13 CSU Red Tag, Wired
P11250W	8	15 SU Manila Oversize Tag, Wired	P11346	7	(6) 13 CSU Red Tag
P11251	8	15 SU White Oversize Tag	P11347	7	(7) 13 CSU Red Tag
P11252	8	15 SU Yellow Oversize Tag	P11348	7	(8) 13 CSU Red Tag
P11253	8	15 SU Red Oversize Tag	P11348W	7	(8) 13 CSU Red Tag, Wired
P11254	8	15 SU Lt. Blue Oversize Tag			
P11255	8	15 SU Dk. Blue Oversize Tag	P11351	7	(1) 13 CSU Dk. Blue Tag
P11256	8	15 SU Lt. Green Oversize Tag	P11351L	7	(1) 13 CSU Lt. Blue Tag
P11257	8	15 SU Orange Oversize Tag	P11352	7	(2) 13 CSU Dk. Blue Tag
P11258	8	15 SU Pink Oversize Tag	P11352L	7	(2) 13 CSU Lt. Blue Tag
			P11353	7	(3) 13 CSU Dk. Blue Tag
P11301	6	(1) 13 SU Manila Tag	P11353L	7	(3) 13 CSU Lt. Blue Tag
P11302	6	(2) 13 SU Manila Tag	P11354	7	(4) 13 CSU Dk. Blue Tag
P11303	6	(3) 13 SU Manila Tag	P11354L	7	(4) 13 CSU Lt. Blue Tag
P11304	6	(4) 13 SU Manila Tag	P11355	7	(5) 13 CSU Dk. Blue Tag
P11305	6	(5) 13 SU Manila Tag	P11355L	7	(5) 13 CSU Lt. Blue Tag
P11306	6	(6) 13 SU Manila Tag	P11355LW	7	(5) 13 CSU Lt. Blue Tag, Wired
P11307	6	(7) 13 SU Manila Tag	P11355W	7	(5) 13 CSU Dk. Blue Tag, Wired
P11308	6	(8) 13 SU Manila Tag	P11356	7	(6) 13 CSU Dk. Blue Tag
			P11356L	7	(6) 13 CSU Lt. Blue Tag
P11311	7	(1) 13 CSU White Tag	P11357	7	(7) 13 CSU Dk. Blue Tag
P11312	7	(2) 13 CSU White Tag	P11357L	7	(7) 13 CSU Lt. Blue Tag
P11313	7	(3) 13 CSU White Tag	P11358	7	(8) 13 CSU Dk. Blue Tag
P11314	7	(4) 13 CSU White Tag	P11358L	7	(8) 13 CSU Lt. Blue Tag
P11315	7	(5) 13 CSU White Tag	P11358LW	7	(8) 13 CSU Lt. Blue Tag, Wired
P11315W	7	(5) 13 CSU White Tag, Wired	P11358W	7	(8) 13 CSU Dk. Blue Tag, Wired
P11316	7	(6) 13 CSU White Tag			
P11318	7	(8) 13 CSU White Tag	P11361	7	(1) 13 CSU Lt. Green Tag
P11318W	7	(8) 13 CSU White Tag, Wired	P11361D	7	(1) 13 CSU Dk. Green Tag
			P11362	7	(2) 13 CSU Lt. Green Tag
P11321	7	(1) 13 CSU Yellow Tag	P11362D	7	(2) 13 CSU Dk. Green Tag
P11322	7	(2) 13 CSU Yellow Tag	P11363	7	(3) 13 CSU Lt. Green Tag
P11323	7	(3) 13 CSU Yellow Tag	P11363D	7	(3) 13 CSU Dk. Green Tag
P11324	7	(4) 13 CSU Yellow Tag	P11364	7	(4) 13 CSU Lt. Green Tag
P11325	7	(5) 13 CSU Yellow Tag	P11364D	7	(4) 13 CSU Dk. Green Tag
P11325W	7	(5) 13 CSU Yellow Tag, Wired	P11365	7	(5) 13 CSU Lt. Green Tag
P11326	7	(6) 13 CSU Yellow Tag	P11365D	7	(5) 13 CSU Dk. Green Tag
P11327	7	(7) 13 CSU Yellow Tag	P11365DW	7	(5) 13 CSU Dk. Green Tag, Wired
P11328	7	(8) 13 CSU Yellow Tag	P11365W	7	(5) 13 CSU Lt. Green Tag, Wired
P11328W	7	(8) 13 CSU Yellow Tag, Wired	P11366	7	(6) 13 CSU Lt. Green Tag
			P11366D	7	(6) 13 CSU Dk. Green Tag
P11331	7	(1) 13 CSU Lilac Tag	P11367	7	(7) 13 CSU Lt. Green Tag
P11332	7	(2) 13 CSU Lilac Tag	P11367D	7	(7) 13 CSU Dk. Green Tag
P11333	7	(3) 13 CSU Lilac Tag	P11368	7	(8) 13 CSU Lt. Green Tag

Item No.	Page	Description	Item No.	Page	Description
P11368D	7	(8) 13 CSU Dk. Green Tag	P11444	9	(4) Tyvek® White Tag
P11368DW	7	(8) 13 CSU Dk. Green Tag, Wired	P11444W	9	(4) Tyvek® White Tag, Wired
P11368W	7	(8) 13 CSU Lt. Green Tag, Wired	P11445	9	(5) Tyvek® White Tag
P11371	7	(1) 13 CSU Orange Tag	P11445W	9	(5) Tyvek® White Tag, Wired
P11372	7	(2) 13 CSU Orange Tag	P11446	9	(6) Tyvek® White Tag
P11373	7	(3) 13 CSU Orange Tag	P11446W	9	(6) Tyvek® White Tag, Wired
P11374	7	(4) 13 CSU Orange Tag	P11447	9	(7) Tyvek® White Tag
P11375	7	(5) 13 CSU Orange Tag	P11447W	9	(7) Tyvek® White Tag, Wired
P11375W	7	(5) 13 CSU Orange Tag, Wired	P11448	9	(8) Tyvek® White Tag
P11376	7	(6) 13 CSU Orange Tag	P11448W	9	(8) Tyvek® White Tag, Wired
P11377	7	(7) 13 CSU Orange Tag	P11455	9	(5) Tyvek® Blue Tag
P11378	7	(8) 13 CSU Orange Tag	P11455W	9	(5) Tyvek® Blue Tag, Wired
P11378W	7	(8) 13 CSU Orange Tag, Wired	P11458	9	(8) Tyvek® Blue Tag
P11381	7	(1) 13 CSU Pink Tag	P11458W	9	(8) Tyvek® Blue Tag, Wired
P11382	7	(2) 13 CSU Pink Tag	P11491	6	(1) 10 SU Manila Tag
P11383	7	(3) 13 CSU Pink Tag	P11492	6	(2) 10 SU Manila Tag
P11384	7	(4) 13 CSU Pink Tag	P11493	6	(3) 10 SU Manila Tag
P11385	7	(5) 13 CSU Pink Tag	P11494	6	(4) 10 SU Manila Tag
P11385W	7	(5) 13 CSU Pink Tag, Wired	P11495	6	(5) 10 SU Manila Tag
P11386	7	(6) 13 CSU Pink Tag	P11496	6	(6) 10 SU Manila Tag
P11387	7	(7) 13 CSU Pink Tag	P11497	6	(7) 10 SU Manila Tag
P11388	7	(8) 13 CSU Pink Tag	P11498	6	(8) 10 SU Manila Tag
P11388W	7	(8) 13 CSU Pink Tag, Wired	P11501	6	(1) 13 SU Manila Tag, Strung
P11391	7	(1) 13 CSU Gray Tag	P11502	6	(2) 13 SU Manila Tag, Strung
P11392	7	(2) 13 CSU Gray Tag	P11503	6	(3) 13 SU Manila Tag, Strung
P11393	7	(3) 13 CSU Gray Tag	P11504	6	(4) 13 SU Manila Tag, Strung
P11394	7	(4) 13 CSU Gray Tag	P11505	6	(5) 13 SU Manila Tag, Strung
P11395	7	(5) 13 CSU Gray Tag	P11506	6	(6) 13 SU Manila Tag, Strung
P11395W	7	(5) 13 CSU Gray Tag, Wired	P11507	6	(7) 13 SU Manila Tag, Strung
P11396	7	(6) 13 CSU Gray Tag	P11508	6	(8) 13 SU Manila Tag, Strung
P11397	7	(7) 13 CSU Gray Tag	P11601	6	(1) 13 SU Manila Tag, Wired
P11398	7	(8) 13 CSU Gray Tag	P11602	6	(2) 13 SU Manila Tag, Wired
P11398W	7	(8) 13 CSU Gray Tag, Wired	P11603	6	(3) 13 SU Manila Tag, Wired
P11415	9	(5) Tyvek® Red Tag	P11604	6	(4) 13 SU Manila Tag, Wired
P11415W	9	(5) Tyvek® Red Tag, Wired	P11605	6	(5) 13 SU Manila Tag, Wired
P11425	9	(5) Tyvek® Yellow Tag	P11606	6	(6) 13 SU Manila Tag, Wired
P11425W	9	(5) Tyvek® Yellow Tag, Wired	P11607	6	(7) 13 SU Manila Tag, Wired
P11435	9	(5) Tyvek® Green Tag	P11608	6	(8) 13 SU Manila Tag, Wired
P11435W	9	(5) Tyvek® Green Tag, Wired	P11691	6	(1) 10 SU Manila Tag, Wired
P11418	9	(8) Tyvek® Red Tag	P11692	6	(2) 10 SU Manila Tag, Wired
P11418W	9	(8) Tyvek® Red Tag, Wired	P11693	6	(3) 10 SU Manila Tag, Wired
P11428	9	(8) Tyvek® Yellow Tag	P11694	6	(4) 10 SU Manila Tag, Wired
P11428W	9	(8) Tyvek® Yellow Tag, Wired	P11695	6	(5) 10 SU Manila Tag, Wired
P11438	9	(8) Tyvek® Green Tag	P11696	6	(6) 10 SU Manila Tag, Wired
P11438W	9	(8) Tyvek® Green Tag, Wired	P11697	6	(7) 10 SU Manila Tag, Wired
P11441	9	(1) Tyvek® White Tag	P11698	6	(8) 10 SU Manila Tag, Wired
P11441W	9	(1) Tyvek® White Tag, Wired	P11701	8	(1) 13 Fluorescent Red Tag
P11442	9	(2) Tyvek® White Tag	P11702	8	(2) 13 Fluorescent Red Tag
P11442W	9	(2) Tyvek® White Tag, Wired	P11703	8	(3) 13 Fluorescent Red Tag
P11443	9	(3) Tyvek® White Tag	P11704	8	(4) 13 Fluorescent Red Tag
P11443W	9	(3) Tyvek® White Tag, Wired			

# Index

Item No.	Page	Description	Item No.	Page	Description
P11705	8	(5) 13 Fluorescent Red Tag	P11805	6	(5) 13 SU Manila, 4 Gang Tag
P11705W	8	(5) 13 Fluorescent Red Tag, Wired	P11911	7	(1) 13 CSU Brown Tag
P11706	8	(6) 13 Fluorescent Red Tag	P11912	7	(2) 13 CSU Brown Tag
P11706W	8	(6) 13 Fluorescent Red Tag, Wired	P11913	7	(3) 13 CSU Brown Tag
P11707	8	(7) 13 Fluorescent Red Tag	P11914	7	(4) 13 CSU Brown Tag
P11708	8	(8) 13 Fluorescent Red Tag	P11915	7	(5) 13 CSU Brown Tag
P11708W	8	(8) 13 Fluorescent Red Tag, Wired	P11915W	7	(5) 13 CSU Brown Tag, Wired
P11711	8	(1) 13 Fluorescent Chartreuse Tag	P11916	7	(6) 13 CSU Brown Tag
P11712	8	(2) 13 Fluorescent Chartreuse Tag	P11917	7	(7) 13 CSU Brown Tag
P11713	8	(3) 13 Fluorescent Chartreuse Tag	P11918	7	(8) 13 CSU Brown Tag
P11714	8	(4) 13 Fluorescent Chartreuse Tag	P11918W	7	(8) 13 CSU Brown Tag, Wired
P11715	8	(5) 13 Fluorescent Chartreuse Tag	P12200	18	Merchandise Tag, White 2" x 3 1/4"
P11715W	8	(5) 13 Fluorescent Chartreuse Tag, Wired	P12201	18	Merchandise Tag, White 1 3/4" x 2 7/8"
P11716	8	(6) 13 Fluorescent Chartreuse Tag	P12202	18	Merchandise Tag, White 1 7/16" x 2 3/16"
P11716W	8	(6) 13 Fluorescent Chartreuse Tag, Wired	P12203	18	Merchandise Tag, White 1 1/4" x 1 7/8"
P11717	8	(7) 13 Fluorescent Chartreuse Tag	P12204	18	Merchandise Tag, White 1 1/8" x 1 3/4"
P11718	8	(8) 13 Fluorescent Chartreuse Tag	P12205	18	Merchandise Tag, White 1 5/16" x 1 1/2"
P11718W	8	(8) 13 Fluorescent Chartreuse Tag, Wired	P12206	18	Merchandise Tag, White 7/8" x 1 1/4"
P11721	8	(1) 13 Fluorescent Green Tag	P12207	18	Merchandise Tag, White 3/4" x 1 1/8"
P11722	8	(2) 13 Fluorescent Green Tag	P12211	18	Merchandise Tag, White 5/8" x 1 5/16"
P11723	8	(3) 13 Fluorescent Green Tag	P12421	18	Merchandise Tag, Yellow 1 3/4" x 2 7/8"
P11724	8	(4) 13 Fluorescent Green Tag	P12425	18	Merchandise Tag, Yellow 1 5/16" x 1 1/2"
P11725	8	(5) 13 Fluorescent Green Tag	P12441	18	Merchandise Tag, Red 1 3/4" x 2 7/8"
P11725W	8	(5) 13 Fluorescent Green Tag, Wired	P12445	18	Merchandise Tag, Red 1 5/16" x 1 1/2"
P11726	8	(6) 13 Fluorescent Green Tag	P12451	18	Merchandise Tag, Green 1 3/4" x 2 7/8"
P11726W	8	(6) 13 Fluorescent Green Tag, Wired	P12455	18	Merchandise Tag, Green 1 5/16" x 1 1/2"
P11727	8	(7) 13 Fluorescent Green Tag	P14305	9	(5) Vinyl Tags, White
P11728	8	(8) 13 Fluorescent Green Tag	P14308	9	(8) Vinyl Tags, White
P11728W	8	(8) 13 Fluorescent Green Tag, Wired	P14312	16	Metal Rim White Tag 1 5/16" Diameter
P11731	8	(1) 13 Fluorescent Pink Tag	P14313	16	Metal Rim White Tag 1 1/4" Diameter
P11732	8	(2) 13 Fluorescent Pink Tag	P14314	16	Metal Rim White Tag 1 9/16" Diameter
P11733	8	(3) 13 Fluorescent Pink Tag	P14315	16	Metal Rim White Tag 1 7/8" Diameter
P11734	8	(4) 13 Fluorescent Pink Tag	P14325	9	(5) Vinyl Tags, Yellow
P11735	8	(5) 13 Fluorescent Pink Tag	P14328	9	(8) Vinyl Tags, Yellow
P11735W	8	(5) 13 Fluorescent Pink Tag, Wired	P14365	9	(5) Vinyl Tags, Red
P11736	8	(6) 13 Fluorescent Pink Tag	P14368	9	(8) Vinyl Tags, Red
P11736W	8	(6) 13 Fluorescent Pink Tag, Wired	P14375	9	(5) Vinyl Tags, Blue
P11737	8	(7) 13 Fluorescent Pink Tag	P14378	9	(8) Vinyl Tags, Blue
P11738	8	(8) 13 Fluorescent Pink Tag	P14385	9	(5) Vinyl Tags, Green
P11738W	8	(8) 13 Fluorescent Pink Tag, Wired	P14388	9	(8) Vinyl Tags, Green
P11741	8	(1) 13 Fluorescent Orange Tag	P14395	9	(5) Vinyl Tags, Orange
P11742	8	(2) 13 Fluorescent Orange Tag	P14398	9	(8) Vinyl Tags, Orange
P11743	8	(3) 13 Fluorescent Orange Tag	P14323	9	3" Circle Vinyl Tag, Yellow
P11744	8	(4) 13 Fluorescent Orange Tag	P14343	9	3" Circle Vinyl Tag, Red
P11745	8	(5) 13 Fluorescent Orange Tag	P14353	9	3" Circle Vinyl Tag, Blue
P11745W	8	(5) 13 Fluorescent Orange Tag, Wired	P14363	9	3" Circle Vinyl Tag, Green
P11746	8	(6) 13 Fluorescent Orange Tag, Strung	P14373	9	3" Circle Vinyl Tag, White
P11746W	8	(6) 13 Fluorescent Orange Tag, Wired			
P11747	8	(7) 13 Fluorescent Orange Tag			
P11748	8	(8) 13 Fluorescent Orange Tag			
P11748W	8	(8) 13 Fluorescent Orange Tag, Wired			

Item No.	Page	Description	Item No.	Page	Description
P15016	17	Inspected Tag	P15308	12	(8) Inventory (2 Pt) (4000 - 4499)
P15017	17	Rejected Tag	P15309	12	(8) Inventory (2 Pt) (4500 - 4999)
P15021	17	Accepted Tag, Lt. Green	P15310	12	(8) Inventory (2 Pt) (5000 - 5499)
P15022	17	Rejected Tag (2 Pt) (000-499)	P15311	12	(8) Inventory (2 Pt) (5500 - 5999)
P15023	17	Rejected Tag (2 Pt) (500-999)	P15312	12	(8) Inventory (2 Pt) (6000 - 6499)
P15024	17	Repair/Rework Tag (2 Pt) (000-499)	P15313	12	(8) Inventory (2 Pt) (6500 - 6999)
P15028	17	Scrap Tag (2 Pt) (000-499)	P15314	12	(8) Inventory (2 Pt) (7000 - 7499)
			P15315	12	(8) Inventory (2 Pt) (7500 - 7999)
P15030	19	Repair Tag, Strung (000-999)	P15316	12	(8) Inventory (2 Pt) (8000 - 8499)
P15032	19	Repair Tag, Strung (1000-1999)	P15317	12	(8) Inventory (2 Pt) (8500 - 8999)
P15040	19	Layaway Tag, Strung (000-499)	P15318	12	(8) Inventory (2 Pt) (9000 - 9499)
			P15319	12	(8) Inventory (2 Pt) (9500 - 9999)
P15050	16	Danger Tag	P15380	12	(8) Inventory (2 Pt) (10000 - 10499)
			P15381	12	(8) Inventory (2 Pt) (10500 - 10999)
P15083	23	Furniture Price Tag, Blue, Strung	P15382	12	(8) Inventory (2 Pt) (11000 - 11499)
P15084	23	Furniture Price Tag, Ivory, Strung	P15383	12	(8) Inventory (2 Pt) (11500 - 11999)
P15086	23	Utility Price Tag, Strung	P15384	12	(8) Inventory (2 Pt) (12000 - 12499)
			P15385	12	(8) Inventory (2 Pt) (12500 - 12999)
P15088	21	Sale Tag, Large	P15386	12	(8) Inventory (2 Pt) (13000 - 13499)
			P15387	12	(8) Inventory (2 Pt) (13500 - 13999)
P15100	14	(8) Inventory (2 Pt) (0000-0499)	P15388	12	(8) Inventory (2 Pt) (14000 - 14499)
P15101	14	(8) Inventory (2 Pt) (0500-0999)	P15389	12	(8) Inventory (2 Pt) (14500 - 14999)
P15102	14	(8) Inventory (2 Pt) (1000-1499)	P15390	12	(8) Inventory (2 Pt) (15000 - 15499)
P15103	14	(8) Inventory (2 Pt) (1500-1999)	P15391	12	(8) Inventory (2 Pt) (15500 - 15999)
P15104	14	(8) Inventory (2 Pt) (2000-2499)	P15392	12	(8) Inventory (2 Pt) (16000 - 16499)
P15105	14	(8) Inventory (2 Pt) (2500-2999)	P15393	12	(8) Inventory (2 Pt) (16500 - 16999)
P15106	14	(8) Inventory (2 Pt) (3000-3499)	P15394	12	(8) Inventory (2 Pt) (17000 - 17499)
P15107	14	(8) Inventory (2 Pt) (3500-3999)	P15395	12	(8) Inventory (2 Pt) (17500 - 17999)
P15108	14	(8) Inventory (2 Pt) (4000-4499)	P15396	12	(8) Inventory (2 Pt) (18000 - 18499)
P15109	14	(8) Inventory (2 Pt) (4500-4999)	P15397	12	(8) Inventory (2 Pt) (18500 - 18999)
P15110	14	(8) Inventory (2 Pt) (5000-5499)	P15398	12	(8) Inventory (2 Pt) (19000 - 19499)
P15111	14	(8) Inventory (2 Pt) (5500-5999)	P15399	12	(8) Inventory (2 Pt) (19500 - 19999)
P15112	14	(8) Inventory (2 Pt) (6000-6499)			
P15113	14	(8) Inventory (2 Pt) (6500-6999)	P15360	11	(8) Inventory (2 Pt) (0000-0499)
P15114	14	(8) Inventory (2 Pt) (7000-7499)	P15361	11	(8) Inventory (2 Pt) (0500-0999)
P15115	14	(8) Inventory (2 Pt) (7500-7999)	P15362	11	(8) Inventory (2 Pt) (1000-1499)
P15116	14	(8) Inventory (2 Pt) (8000-8499)	P15363	11	(8) Inventory (2 Pt) (1500-1999)
P15117	14	(8) Inventory (2 Pt) (8500-8999)	P15364	11	(8) Inventory (2 Pt) (2000-2499)
P15118	14	(8) Inventory (2 Pt) (9000-9499)	P15365	11	(8) Inventory (2 Pt) (2500-2999)
P15119	14	(8) Inventory (2 Pt) (9500-9999)	P15366	11	(8) Inventory (2 Pt) (3000-3499)
			P15367	11	(8) Inventory (2 Pt) (3500-3999)
P15166	22	Hold Tag	P15368	11	(8) Inventory (2 Pt) (4000-4499)
			P15369	11	(8) Inventory (2 Pt) (4500-4999)
P15208	20	Sale Price Tag, Strung			
P15220	20	Special Sale Tag	P15400	11	(8) Inventory Manila (0000-0999)
P15251	20	Special Sale Tag, Strung	P15401	11	(8) Inventory Manila (1000-1999)
			P15402	11	(8) Inventory Manila (2000-2999)
P15300	12	(8) Inventory (2 Pt) (0000 - 0499)	P15403	11	(8) Inventory Manila (3000-3999)
P15301	12	(8) Inventory (2 Pt) (0500 - 0999)	P15404	11	(8) Inventory Manila (4000-4999)
P15302	12	(8) Inventory (2 Pt) (1000 - 1499)	P15405	11	(8) Inventory Manila (5000-5999)
P15303	12	(8) Inventory (2 Pt) (1500 - 1999)	P15406	11	(8) Inventory Manila (6000-6999)
P15304	12	(8) Inventory (2 Pt) (2000 - 2499)	P15407	11	(8) Inventory Manila (7000-7999)
P15305	12	(8) Inventory (2 Pt) (2500 - 2999)	P15408	11	(8) Inventory Manila (8000-8999)
P15306	12	(8) Inventory (2 Pt) (3000 - 3499)	P15409	11	(8) Inventory Manila (9000-9999)
P15307	12	(8) Inventory (2 Pt) (3500 - 3999)	P15410	11	(8) Inventory Manila (10000-10999)
			P15411	11	(8) Inventory Manila (11000-11999)

# Index

Item No.	Page	Description	Item No.	Page	Description
P15412	11	(8) Inventory Manila (12000-12999)	P15545	12	(8) Inventory (2 Pt) (7500-7999)
P15413	11	(8) Inventory Manila (13000-13999)	P15546	12	(8) Inventory (2 Pt) (8000-8499)
P15414	11	(8) Inventory Manila (14000-14999)	P15547	12	(8) Inventory (2 Pt) (8500-8999)
P15415	11	(8) Inventory Manila (15000-15999)	P15548	12	(8) Inventory (2 Pt) (9000-9499)
P15416	11	(8) Inventory Manila (16000-16999)	P15549	12	(8) Inventory (2 Pt) (9500-9999)
P15417	11	(8) Inventory Manila (17000-17999)			
P15418	11	(8) Inventory Manila (18000-18999)	P15720	13	(8) Inventory (3 Pt) (00000-00499)
P15419	11	(8) Inventory Manila (19000-19999)	P15721	13	(8) Inventory (3 Pt) (00500-00999)
			P15722	13	(8) Inventory (3 Pt) (01000-01499)
P15420	10	(8) Blank (3 Pt) (0000-0499)	P15723	13	(8) Inventory (3 Pt) (01500-01999)
P15421	10	(8) Blank (3 Pt) (0500-0999)	P15724	13	(8) Inventory (3 Pt) (02000-02499)
P15422	10	(8) Blank (3 Pt) (1000-1499)	P15725	13	(8) Inventory (3 Pt) (02500-02999)
P15423	10	(8) Blank (3 Pt) (1500-1999)	P15726	13	(8) Inventory (3 Pt) (03000-03499)
P15424	10	(8) Blank (3 Pt) (2000-2499)	P15727	13	(8) Inventory (3 Pt) (03500-03999)
P15425	10	(8) Blank (3 Pt) (2500-2999)	P15728	13	(8) Inventory (3 Pt) (04000-04499)
P15426	10	(8) Blank (3 Pt) (3000-3499)	P15729	13	(8) Inventory (3 Pt) (04500-04999)
P15427	10	(8) Blank (3 Pt) (3500-3999)	P15730	13	(8) Inventory (3 Pt) (05000-05499)
P15428	10	(8) Blank (3 Pt) (4000-4499)	P15731	13	(8) Inventory (3 Pt) (05500-05999)
P15429	10	(8) Blank (3 Pt) (4500-4999)	P15732	13	(8) Inventory (3 Pt) (06000-06499)
			P15733	13	(8) Inventory (3 Pt) (06500-06999)
P15500	14	(8) Inventory (2 Pt) T-Tape (0000-0499)	P15734	13	(8) Inventory (3 Pt) (07000-07499)
P15501	14	(8) Inventory (2 Pt) T-Tape (0500-0999)	P15735	13	(8) Inventory (3 Pt) (07500-07999)
P15502	14	(8) Inventory (2 Pt) T-Tape (1000-1499)	P15736	13	(8) Inventory (3 Pt) (08000-08499)
P15503	14	(8) Inventory (2 Pt) T-Tape (1500-1999)	P15737	13	(8) Inventory (3 Pt) (08500-08999)
P15504	14	(8) Inventory (2 Pt) T-Tape (2000-2499)	P15738	13	(8) Inventory (3 Pt) (09000-09499)
P15505	14	(8) Inventory (2 Pt) T-Tape (2500-2999)	P15739	13	(8) Inventory (3 Pt) (09500-09999)
P15506	14	(8) Inventory (2 Pt) T-Tape (3000-3499)	P15740	13	(8) Inventory (3 Pt) (10000-10499)
P15507	14	(8) Inventory (2 Pt) T-Tape (3500-3999)	P15741	13	(8) Inventory (3 Pt) (10500-10999)
P15508	14	(8) Inventory (2 Pt) T-Tape (4000-4499)	P15742	13	(8) Inventory (3 Pt) (11000-11499)
P15509	14	(8) Inventory (2 Pt) T-Tape (4500-4999)	P15743	13	(8) Inventory (3 Pt) (11500-11999)
P15510	14	(8) Inventory (2 Pt) T-Tape (5000-5499)	P15744	13	(8) Inventory (3 Pt) (12000-12499)
P15511	14	(8) Inventory (2 Pt) T-Tape (5500-5999)	P15745	13	(8) Inventory (3 Pt) (12500-12999)
P15512	14	(8) Inventory (2 Pt) T-Tape (6000-6499)	P15746	13	(8) Inventory (3 Pt) (13000-13499)
P15513	14	(8) Inventory (2 Pt) T-Tape (6500-6999)	P15747	13	(8) Inventory (3 Pt) (13500-13999)
P15514	14	(8) Inventory (2 Pt) T-Tape (7000-7499)	P15748	13	(8) Inventory (3 Pt) (14000-14499)
P15515	14	(8) Inventory (2 Pt) T-Tape (7500-7999)	P15749	13	(8) Inventory (3 Pt) (14500-14999)
P15516	14	(8) Inventory (2 Pt) T-Tape (8000-8499)			
P15517	14	(8) Inventory (2 Pt) T-Tape (8500-8999)	P18109	5	Unpolished Cotton Loose String 12" x #9
P15518	14	(8) Inventory (2 Pt) T-Tape (9000-9499)	P18111	5	Loose Knotted White Elastic
P15519	14	(8) Inventory (2 Pt) T-Tape (9500-9999)			
			P18310	15	Key Rings, 7/8"
P15530	12	(8) Inventory (2 Pt) (0000-0499)			
P15531	12	(8) Inventory (2 Pt) (0500-0999)	P18412	5	Loose Wire 12" x 21 Gauge
P15532	12	(8) Inventory (2 Pt) (1000-1499)	P18432	5	Loose Wire 12" x 23 Gauge
P15533	12	(8) Inventory (2 Pt) (1500-1999)	P18462	5	Loose Wire 12" x 26 Gauge
P15534	12	(8) Inventory (2 Pt) (2000-2499)	P18462-500	5	Loose Wire 12" x 26 Gauge
P15535	12	(8) Inventory (2 Pt) (2500-2999)	P18467	5	Loose Wire 7 1/2" x 26 Gauge
P15536	12	(8) Inventory (2 Pt) (3000-3499)	P18505	5	Copper Parcel Hook
P15537	12	(8) Inventory (2 Pt) (3500-3999)	P18541	5	Diamond Deadlock, Sharp
P15538	12	(8) Inventory (2 Pt) (4000-4499)	P18542	5	Diamond Deadlock, Blunt
P15539	12	(8) Inventory (2 Pt) (4500-4999)	P18543	5	Diamond Deadlock, Semi-Blunt
P15540	12	(8) Inventory (2 Pt) (5000-5499)	P18547	5	Oval Deadlock, Sharp
P15541	12	(8) Inventory (2 Pt) (5500-5999)	P18548	5	Oval Deadlock, Blunt
P15542	12	(8) Inventory (2 Pt) (6000-6499)			
P15543	12	(8) Inventory (2 Pt) (6500-6999)	P18670	26	Hospitality Duplicate Tags (000-499)
P15544	12	(8) Inventory (2 Pt) (7000-7499)	P18671	26	Hospitality Duplicate Tags (500-999)



Item No.	Page	Description	Item No.	Page	Description
P18940	27	Valet Parking Claim Check (0001-1000)	P72501	23	Carpet Remnant Tag
P18941	27	Parking Claim Check (000-999)	P72504	23	Carpet Roll Inventory Tag
P18942	27	Valet Parking Tag (000-999)	P72507	23	No-Rip Tyvek® Carpet Roll Tag
P18945	27	Parking Permit (0000-0499)			
P18950	24	Luggage Tag (000-999)	P95886	22	Rifle ID Tag
P18951	25	Baggage ID Tag w/T-Tape (000-999)	P96345	18	Large Garment Tag, White
P18952	25	Cohesive Bag Tag (000-999)	P99500	18	Small Garment Tag, White
P18953	25	Baggage Claim Check (000-999)			
P18961	26	Lost and Found	P99701	19	Alteration Tag w/Button Slot
P18980	26	Claim Check Tag, White (000-999)	P99704	19	Alteration Tag, Strung
P18981	26	Claim Check Tag, Yellow (000-999)			
P18982	26	Claim Check Tag, Lt. Blue (000-999)	P99707	23	Carpet Inventory Record Tag
P18983	26	Claim Check Tag, Lt Grn. (000-999)			
P18984	26	Claim Check Tag, Cherry (000-999)			
P55500	15	Auto ID Tag, Red/Grn (000-999)			
P55501	15	Auto ID Tag, Red/Grn (1000-1999)			
P55502	15	Auto ID Tag, Red/Grn (2000-2999)			
P55503	15	Auto ID Tag, Red/Grn (3000-3999)			
P55504	15	Auto ID Tag, Red/Grn (4000-4999)			
P55505	15	Auto ID Tag, Red/Grn (5000-5999)			
P55506	15	Auto ID Tag, Red/Grn (6000-6999)			
P55507	15	Auto ID Tag, Red/Grn (7000-7999)			
P55508	15	Auto ID Tag, Red/Grn (8000-8999)			
P55509	15	Auto ID Tag, Red/Grn (9000-9999)			
P55520	15	Paper Key Tag w/Ring, White			
P55521	15	Paper Key Tag w/Ring, Yellow			
P55522	15	Paper Key Tag w/Ring, Red			
P55523	15	Paper Key Tag w/Ring, Lt. Blue			
P55524	15	Paper Key Tag w/Ring, Lt. Green			
P55525	15	Paper Key Tag w/Ring, Orange			
P60300	24	Manifold Bag Tag w/6 Labels (0000-0999)			
P60310	27	Valet Parking Check (0000-0999)			
P60320	24	Baggage ID Tag (00000-00999)			
P60330	27	Park Check (00000-00999)			
P72003	20	Retail Tag, Strung			
P72202	21	Sale Was/Now Tag			
P72209	21	Sale Tag			
P72301	22	Red Sold Tag, Printed Black			
P72302	22	White Sold Tag, Printed Red			
P72303	22	I'm Sold But Tag			
P72324	21	Sale Tag			
P72405	20	Special Sale Tag			
P72407	20	Regular Price/Our Price Tag			
P72408	20	Sale Sale Sale Tag			



# Terms & Conditions of Sale

---

This catalog constitutes an offer to sell goods and/or provide services at the terms set out in this catalog. All sales of goods or services from this catalog are subject to the terms and conditions set out at [printtermsandconditions.com](http://printtermsandconditions.com). The terms and conditions contain important legal information. Please review them carefully.

**TERMS: MINIMUM ORDER IS \$50 NET VALUE. ORDERS UNDER THE MINIMUM ORDER REQUIREMENT WILL NOT BE ACCEPTED. ALL ORDERS ARE SUBJECT TO FINAL ACCEPTANCE BY THE SELLER.**

**PRICE:** Dealer net prices are shown in the price list. Prices are subject to change without notice. Every attempt is made to adequately announce price changes in advance of their effective dates to our customers.

**PAYMENT TERMS:** Net 30 days to approved accounts. MasterCard, VISA, Amex and Discover are accepted. Payment in advance is required for all other accounts.

**DELIVERY TERMS:** Shipments typically made within 24 hours\*. FOB Neenah, WI. (\*Subject to availability.)

**PRODUCT RETURNS:** Returns must have prior approval. 15 day return policy with a 25% restocking fee. If call tags need to be issued, charges may apply. Customer is responsible for freight on all returned goods.

**SALES TAX:** Applicable sales and use tax will be charged unless you provide us with a valid tax exemption certificate.

**CUSTOM PRODUCTS:** Items which require printing or custom manufacturing other than indicated in this catalog are available by special order. Please call our toll-free number and your sales representative will be happy to assist you.

**LIMITATION OF WARRANTY:** The seller's products are warranted to be free from defects in material and workmanship and suitable for normal conditions of use for which they are sold. No other warranties, expressed or implied, shall apply to our products, including but not limited to NO IMPLIED WARRANTIES OF MERCHANTABILITY OR FITNESS FOR A PARTICULAR PURPOSE. Our liability for breach of warranty shall be limited to replacement of defective products or refund of the amount paid for the defective products. In no event will we be liable for any other amounts, including consequential, indirect or special damages.



**Special Service Partners**  
**1265 Gillingham Road • Neenah, WI 54956**  
**800.558.6443 • 800.451.7553 Fax**  
**ssp@ssptag.com • ssptag.com**